

UNIVERSITY OF CALGARY

Integral Categories and Calculus Categories

by

Jean-Simon Pacaud Lemay

A THESIS

SUBMITTED TO THE FACULTY OF GRADUATE STUDIES
IN PARTIAL FULFILLMENT OF THE REQUIREMENTS FOR THE
DEGREE OF MASTERS OF SCIENCE

GRADUATE PROGRAM IN MATHEMATICS AND STATISTICS

CALGARY, ALBERTA

April, 2017

© Jean-Simon Pacaud Lemay 2017

Abstract

Differential categories are now a well-studied abstract setting for differentiation. However not much attention has been given to the process which is inverse to differentiation: integration. This thesis presents an analogous study of integral categories. Integral categories give an abstraction of integration by axiomatizing extra structure on a symmetric monoidal categories with a coalgebra modality using the primary rules of integration. The axioms for integrations include the analogues of integration by parts rule, also called the Rota-Baxter rule, the independence of the order of iterated integrals and that integral of any constant map is linear. We expect consequences of the compatible interaction between integration and differentiation to include the two fundamental theorems of calculus. A differential category with integration which satisfies these two theorem in a suitable sense is what we call a *calculus category*.

Acknowledgements

First and foremost, many thanks to my incredible supervisors Professors Kristine Bauer and Robin Cockett. Thank you both for your endless kindness, support and help. Kristine, your door was always open to me whenever I had a problem or just wanted to talk. Robin, you seemed always available and excited to work on and explore math countless hours at a whiteboard. My incredible experience during masters degree would not have been possible without either of you.

Secondly, I would also like to thank Professor Richard Blute of the University of Ottawa for introducing me to differential categories and shipping me off to work with Robin. It was also Rick's idea to use Rota-Baxter algebras as an inspiration for the development of integral categories. Integral categories simply would not have developed so rapidly without this basic inspiration.

Thank you to Professors Claude Laflamme and Berndt Brenken of the University of Calgary and to Professor Christine Tasson of Université Paris Diderot for being on my Examination committee and suffering through reading all my string diagrams.

Many thanks to all my friends from childhood, swimming, the lake, high-school, undergrad and my master's: you are all awesome.

Finally, and most of all, I would like to thank my family, which I will do in french. J'aimerais dire un énorme merci à toute ma famille pour l'amour et le support que vous m'aviez offert durant toute ma vie et surtout mes études. A mon père Jean-François, ma mère Danièle, ma soeur Julie-Anne, ma grand-maman France, ma grand-maman Pacaud, mon parrain Eric, ma marraine Marie-Claude, mon oncle Bernard, mon oncle Jean, ma tante Mélanie, mes cousines Sophie, Isabelle, Justine et Charlotte, et ma blonde Nuiok : je vous aime tous. Merci.

Je dédie cette thèse à mes deux grand-papas : Henry-Paul Lemay et Yvan Pacaud. Vous me manquez et je vous aime.

Table of Contents

Abstract	ii
Acknowledgements	iii
Dedication	v
Table of Contents	vi
List of Tables	viii
List of Symbols, Abbreviations and Nomenclature	ix
Epigraph	x
1 Introduction	1
1.1 Background: Differential Categories	2
1.2 Objectives: Integral and Calculus Categories	3
1.3 Outline	6
2 Preliminaries	9
2.1 Additive Symmetric Monoidal Categories	9
2.2 Coalgebra Modality	16
2.3 Graphical Calculus	23
3 Integral Categories	26
3.1 Integral Combinator	27
3.2 Naturality of the Integral Combinator	31
3.3 Integral Transformation	34
3.4 Main Examples of Integral Categories	40
3.5 Polynomial Integration and Rationals	42
3.6 Other Integral Properties	53
3.7 Fubini's theorem	58
4 Differential Categories	60
4.1 Differential Combinator	60
4.2 Naturality of the Differential Combinator	63

4.3	Deriving Transformation	65
4.4	Main Examples of Differential Categories	72
5	Calculus Categories	75
5.1	Second Fundamental Theorem of Calculus	77
5.2	Compatibility and Taylor	79
5.3	First Fundamental Theorem of Calculus	82
5.4	Poincaré Condition	85
5.5	Calculus Category	88
6	From a Differential Category to a Calculus Category	91
6.1	The Coderiving Transformation and the W Map	93
6.2	The L, K and J Maps	100
6.3	Antiderivatives: the K^{-1} and J^{-1} Maps	118
6.4	From Antiderivatives to Calculus Categories	135
7	Conclusion and Future Work	141
7.1	Original Contributions	141
7.2	Overview of Examples	142
7.3	Future Work	149
	Bibliography	151

List of Tables

2.1	Graphical Calculus Reference	24
2.2	Coalgebra Modality Properties in String Diagrams	25
5.1	Properties for Calculus Categories	89
6.1	Properties of the coderiving transformation	96
6.2	Properties of \mathbf{L}	105
6.3	Properties of \mathbf{K}	109
6.4	Properties of \mathbf{J} , Part 1	113
6.5	Properties of \mathbf{J} , Part 2	114
6.6	Properties of \mathbf{K}^{-1}	126
6.7	Properties of \mathbf{J}^{-1}	132

List of Symbols, Abbreviations and Nomenclature

\mathbb{X}	Category
\otimes	Tensor product of symmetric monoidal categories
K	Unit of symmetric monoidal categories
α	Associativity isomorphism of symmetric monoidal categories
λ	Left unit isomorphism of symmetric monoidal categories
ρ	Right unit isomorphism of symmetric monoidal categories
σ	Symmetry isomorphism of symmetric monoidal categories
$f + g$	Sum of parallel maps f and g
0	Zero map
$n \cdot f$	Scalar multiplication of a map f by a natural number n
$!$	Endofunctor of a comonad
δ	Comultiplication of a comonad
ε	Counit of a comonad
Δ	Comultiplication of a comonoid
e	Counit of a comonoid
Δ^n	n -fold Comultiplication of a comonoid
S	Integral combinator
s	Integral transformation
\diamond	Integrating multiplication
D	Differential combinator
d	Deriving transformation
\emptyset	Empty set
$\{*\}$	Singleton set
$\llbracket x_1, \dots, x_n \rrbracket$	Finite bag/multiset
\oplus	Coproduct of vector spaces
d°	Coderiving transformation
L	L-map
J	J-map
K	K-map
W	W-map

Epigraph

*I really need to restructure my life so I can spend more time reading abstracts
and less time punching dinosaurs.*

-Atomic Robo, *The Shadow From Beyond Time*, Issue 5

Chapter 1

Introduction

Classical calculus, developed by Gottfried Leibniz and Isaac Newton, is one of the most important, successful and applicable developments of mathematics with applications throughout all of science, economics and engineering. The two fundamental theorems of calculus relate the two most important operations of calculus: differentiation and integration. The first theorem states that the derivative of the integral of a function $f : \mathbb{R} \rightarrow \mathbb{R}$ is the original function f :

$$\frac{d(\int_a^t f(u) \, du)}{dt}(x) = f(x) \quad (\text{FTC1})$$

while the second states that the integral of the derivative of a function $f : \mathbb{R} \rightarrow \mathbb{R}$ on a closed interval $[a, b]$ is equal to the difference of f evaluated at the end points:

$$\int_a^b \frac{df(t)}{dt}(x) \, dx = f(b) - f(a). \quad (\text{FTC2})$$

They are called “fundamental” theorems because they are absolutely fundamental to the development of classical calculus.

Since the turn of the 21st century, there has been significant progress in the abstract

understanding of differentiation in category theory. In contrast, the abstract formulation of integration has not received the same level of attention.

The purpose of this thesis is to provide an abstract formulation of integration and study the fundamental theorems of calculus in this setting.

1.1 Background: Differential Categories

In the early 2000's, T. Ehrhard and L. Regnier introduced the differential λ -calculus [16] and differential proof nets [17], which formalized differentiation in linear logic [19], a form of logic introduced by J-Y. Girard which is modelled by symmetric monoidal categories. A few years later, R. Blute, R. Cockett and R. Seely introduced differential categories [8], which were the appropriate categorical structure for modelling Ehrhard and Regnier's differential linear logic. Differential categories give an axiomatization of differentiation based on properties of the classical definition of the derivative of functions from calculus. These axioms encode the fact that the derivative of a linear function is a constant, that the derivative of a constant is zero, the product rule and the chain rule. Many results in differential calculus are consequences of these basic axioms. For example the basic properties of partial derivatives, the higher order product rule and the Faa di Bruno formula for the higher order chain rule are consequences.

This abstract formalization of differentiation does not require the notion of limit. As a consequence, this limit independent description allows us to study differential calculus in a variety of non-standard settings. There are many examples of differential categories. In particular, an important example is the category of vector spaces, where the differential structure coincides with the usual differentiation of multivariable polynomial functions. More surprising examples of differential categories include the category of sets and relations,

the category of sup-lattices and the category of modules over rigs (rings without negatives [20]). This abstract differentiation has applications in differential geometry, algebraic geometry, physics, quantum physics, linear logic, programming and game theory.

Differential categories now have a rich literature of their own [7, 9, 10, 11, 18, 27, 30] and there are many examples which have been extensively studied. However, as mentioned before, little attention has been given to abstracting the process of integration.

In 2014, T. Ehrhard observed that in certain $*$ -autonomous categories [2] which had the appropriate structure to be a differential category, it was possible with one additional assumption to obtain antiderivatives [15]. The additional assumption was that a natural transformation named J , which all differential categories have, was a natural isomorphism. With this assumption, Ehrhard constructed an integral with an inverse behaviour to the differential in the sense that he gave necessary and sufficient conditions for a *map* to satisfy the first fundamental theorem of calculus. Ehrhard called this the Poincaré Lemma, analogous to the result of the same name in cohomology [35] and differential topology [] which specifies when certain forms are exact or have an antiderivative. Furthermore, when the deriving transformation satisfied an extra condition, which he called the “Taylor Property”, one could prove that every differentiable function satisfied the second fundamental theorem of calculus.

While much of the inspiration for our approach to integration derives from these observations, Ehrhard made no attempt to axiomatize integration separately from differentiation.

1.2 Objectives: Integral and Calculus Categories

The main objective of this thesis is to develop the theory of integral categories. In particular, we introduce integral categories as a notion which stands on its own in the absence of differ-

entiation. This will give an algebraic and measure independent formalization of integration that allows the structure, properties and results of integral calculus to be easily transferred from one field of mathematics to another. In particular, integral categories will give a better understanding of integration in a variety of settings such as linear logic, tangent categories, differential geometry, algebraic geometry, tropical geometry, and synthetic differential geometry.

The inspiration for the axiomatization of integration (separate from differentiation) comes from the much older notion of a Rota-Baxter algebra [4, 32, 21], the classical algebraic abstraction of integration. Briefly, for a commutative ring R , a Rota-Baxter algebra of weight λ is an R -algebra A with an R -linear morphism $P : A \rightarrow A$ which satisfies the Rota-Baxter rule:

$$P(a)P(b) = P(aP(b)) + P(P(a)b) + \lambda P(ab) \quad \forall a, b \in A$$

where $\lambda \in R$. The map P is called a Rota-Baxter operator of weight λ . A particular example of a Rota-Baxter algebra of weight zero is the \mathbb{R} -algebra of real continuous functions $\mathbf{Cont}(\mathbb{R})$, where the Rota-Baxter operator $P : \mathbf{Cont}(\mathbb{R}) \rightarrow \mathbf{Cont}(\mathbb{R})$ is defined as the integral of the function centred at zero:

$$P(f)(x) = \int_0^x f(t) \, dt$$

The Rota-Baxter rule for this example is the expression of the integration by parts rule without the use of derivatives (see [21] for more details):

$$\int_0^x f(t) \, dt \cdot \int_0^x g(t) \, dt = \int_0^x f(t) \cdot \left(\int_0^t g(u) \, du \right) \, dt + \int_0^x \left(\int_0^t f(u) \, du \right) \cdot g(t) \, dt$$

This example motivates the idea that the Rota-Baxter rule is one of the fundamental axioms of integration. In particular, a formalization of the Rota-Baxter rule of weight zero will be

one of the axioms of the integral category structure.

The interaction between the integral category and differential category structure is clearly important. When differentiation and integration are compatibly combined into what we call a *calculus category*, we demand that the two fundamental theorems of calculus hold. The second fundamental theorem of calculus is assumed to hold verbatim, that is, every differentiable map satisfies it. However, the first fundamental theorem, as Ehrhard observed, has to be interpreted as being a property which only certain integrable maps satisfy. Under this interpretation, the first fundamental theorem becomes the Poincaré condition which provides necessary and sufficient conditions for a map to be the differential of its integral, that is, to satisfy the first fundamental theorem. Calculus categories give a widely applicable form to the techniques and results of calculus that can be, potentially, used in algebra, geometry, logic, combinatorics, programming, game theory, and quantum physics.

As Ehrhard originally observed, integration can also be obtained from differentiation as a notion of antiderivation. Furthermore, integration induced from differentiation in this manner should satisfy the fundamental theorems of calculus, as is the case in classical calculus. To obtain the notion of integration as an antiderivative, we have followed Ehrhard's original idea but have strengthened his approach. This is due to the fact that requiring \mathbf{J} to be a natural isomorphism is not enough to have an integral category or a calculus category. We instead insist that a slightly different natural transformation, which we call \mathbf{K} , should be invertible in order to obtain integration. This more fundamental transformation not only produces an integral, but also secures the first *and* second fundamental theorems of calculus, thus giving a calculus category. The invertibility of \mathbf{K} also ensures that Ehrhard's natural transformation \mathbf{J} is invertible, but the converse is not true. However, in the presence of the "Taylor Property", which Ehrhard had suggested as being important, the invertibility of \mathbf{J} implies the invertibility of \mathbf{K} . Furthermore, the antiderivative integral produced by the

inverse of K is the same as the antiderivative produced by the inverse of J (when K is already invertible). Significantly, the notion of a differential category with antiderivatives, given by requiring that K is invertible, provides a plentiful supply of calculus categories, in particular the category of sets and relations and the category of vector fields over a fixed field of characteristic zero.

1.3 Outline

We assume a knowledge of basic category theory including the definitions and properties of categories, functors, natural transformation, duality and various kinds of maps (such as isomorphism, epimorphisms, etc.). We refer the reader to the following excellent sources [29, 12, 1, 3] if further details are needed. We also assume basic knowledge of algebra including the definitions and properties of monoids, fields, vector spaces, tensor product of vector spaces and linear transformations. The reader may consult [28] for more details on these topics.

Chapter 2 introduces additive symmetric monoidal category with a coalgebra modality, which is the basic setting for differential, integral and calculus categories. In Section 2.1 we define and give examples of additive symmetric monoidal categories and in Section 2.2 we do the same for coalgebra modalities. We end this chapter by giving a brief introduction to the graphical calculus for additive symmetric monoidal category. The graphical calculus is highly effective tool which allows one to construct proofs visually using string diagrams. We will give a table of reference for all the symbols we will use in our graphical calculus throughout this thesis, Table 2.3.

In Chapter 3 we develop a new concept which is part of the original work of this thesis. We introduce integral categories where we also explore certain properties and provides

examples of them. We illustrate two equivalent ways of defining an integral category with the integral combinator and the integral transformation. Section 3.1 introduces the integral combinator, while Section 3.3 introduces the integral transformation. At the end of Section 3.3 we prove that the two concepts are equivalent. In Section 3.5 we give the polynomial integration identity for integral category and how this implies non-negative rationals in an integral category. Then we give other properties of integral categories in Section 3.6 and finish with a discussion of Fubini's theorem in Section 3.7.

Chapter 4 is a survey of differential categories. The material in this chapter was originally developed in [8]. The structure of this chapter mirrors the structure of the previous chapter on integral categories. We again illustrate two equivalent ways of defining differential with the differential combinator and the deriving transformation, which we also prove are equivalent to one another. We do not explore differential categories in detail, we instead refer the interested reader to other sources.

Chapter 5 introduces the categorical formulation of the fundamental theorems of calculus and introduces calculus categories, which is part of the original work of this thesis. In Section 5.1 we study the definition of the second fundamental theorem in terms of the deriving transformation and integral transformation. Section 5.2 introduces an alternative and equivalent way of stating the second fundamental theorem with the introduction of the Compatibility and Taylor conditions. Section 5.3 explores the definition of the first fundamental theorem of calculus and Section 5.4 introduces the Poincaré Condition. We finish this chapter by providing examples of calculus categories.

In Chapter 6 we provide sufficient conditions for a differential category to be a calculus category. Differential categories with these conditions are said to have antiderivatives. In this chapter we introduce the coderiving transformation and also the W , L , K and J maps.

In Section 6.3, we prove that the invertibility of \mathbf{K} is equivalent to \mathbf{J} being invertible and the Taylor property. Finally in Section 6.4, we prove the main theorem of this thesis, Theorem 6.23, that a differential category with antiderivatives is a calculus category by constructing an integral transformation using \mathbf{K}^{-1} .

In the final chapter, Chapter 7, we provide a summary of the main result of this thesis, an overview of separating examples of the various structures and an indication of how these ideas might be further developed.

Chapter 2

Preliminaries

In this chapter, we establish the basic setting of integral and differential categories: additive symmetric monoidal categories with a coalgebra modality. Before beginning, we should first address conventions that we will be using in these notes. First, we will use diagrammatic order for composition. Explicitly, this means that the composite map $fg : A \rightarrow C$ is the map which first does $f : A \rightarrow B$ then $g : B \rightarrow C$, which is illustrated in the following commutative diagram.

$$\begin{array}{ccc} & & B \\ & \nearrow f & \\ A & & \\ & \xrightarrow{fg} & C \\ & & \searrow g \end{array}$$

Secondly, we will be working in strictly associative symmetric monoidal categories. This will be discussed further after Definition 2.1.

2.1 Additive Symmetric Monoidal Categories

In this section, we recall the definition and examples of additive symmetric monoidal categories. We begin with the definition of a symmetric monoidal category, then we give the definition of additive categories and additive symmetric monoidal categories. We finish this section by describing our two main examples of additive symmetric monoidal categories: the

category of sets and relations and the category of vector spaces, which will also be our main examples of integral and differential categories.

The basic idea of a symmetric monoidal category is a category which is equipped with a notion of a tensor product which behaves like the standard notion of the tensor product for vector spaces. In fact, the category of vector spaces over a fixed field is one of the standard examples of a symmetric monoidal category. The axiomatization of symmetric monoidal categories can be given in various equivalent ways. While the main structure (the category, the tensor product, the tensor unit and the natural isomorphisms) are always the same from one definition to another, the coherence conditions a symmetric monoidal category must satisfy are often expressed differently. While the different axiomatizations, such as [29] or [26], are all equivalent [25], in this thesis we have chosen to express them as found in [3].

Definition 2.1. A **symmetric monoidal category** [3, 26, 29] is a septuple $(\mathbb{X}, \otimes, K, \alpha, \lambda, \rho, \sigma)$ consisting of:

- (i) A category \mathbb{X} ;
- (ii) A bi-functor $\otimes : \mathbb{X} \times \mathbb{X} \rightarrow \mathbb{X}$ called the **monoidal or tensor product**;
- (iii) An object $K \in Ob(\mathbb{X})$ called the **unit**;
- (iv) A natural isomorphism α , with components $\alpha_{A,B,C} : A \otimes (B \otimes C) \cong (A \otimes B) \otimes C$ for triples of objects $A, B, C \in Ob(\mathbb{X})$ (that is α is natural in each of A, B and C separately), called the **associativity isomorphism**;
- (v) A natural isomorphism λ , with components $\lambda_A : K \otimes A \cong A$ for objects $A \in Ob(\mathbb{X})$, called the **left unit isomorphism**;
- (vi) A natural isomorphism ρ , with components $\rho_A : A \otimes K \cong A$ for objects $A \in Ob(\mathbb{X})$, called the **right unit isomorphism**;

(vii) A natural isomorphism σ , with components $\sigma_{A,B} : A \otimes B \cong B \otimes A$ for pairs of objects $A, B \in \text{Ob}(\mathbb{X})$ (that is σ is natural in both A and B separately), called the **symmetry isomorphism**.

The septuple $(\mathbb{X}, \otimes, K, \alpha, \lambda, \rho, \sigma)$ satisfies the following properties [3]:

[SMC.1] For all quadruples of objects $A, B, C, D \in \mathbb{X}$, the following diagram, called the **associativity pentagon**, commutes:

$$\begin{array}{ccc}
 A \otimes (B \otimes (C \otimes D)) & \xrightarrow{\alpha_{A,B,C \otimes D}} & (A \otimes B) \otimes (C \otimes D) \\
 1_A \otimes \alpha_{B,C,D} \downarrow & & \downarrow \alpha_{A \otimes B, C, D} \\
 A \otimes ((B \otimes C) \otimes D) & & \\
 \alpha_{A,B \otimes C, D} \downarrow & & \\
 (A \otimes (B \otimes C)) \otimes D & \xrightarrow{\alpha_{A,B,C} \otimes 1_D} & ((A \otimes B) \otimes C) \otimes D
 \end{array}$$

[SMC.2] For all pairs of objects $A, B \in \mathbb{X}$, the following diagram, called the **unit associativity triangle**, commutes:

$$\begin{array}{ccc}
 A \otimes (K \otimes B) & \xrightarrow{\alpha_{A,K,B}} & (A \otimes K) \otimes B \\
 \searrow 1_A \otimes \lambda_B & & \nearrow \rho_A^{-1} \otimes 1_B \\
 & A \otimes B &
 \end{array}$$

[SMC.3] For each pair of objects $A, B \in \mathbb{X}$, the following diagram, called **symmetry inverse triangle**, commutes:

$$\begin{array}{ccc}
 A \otimes B & \xlongequal{\quad\quad\quad} & A \otimes B \\
 \searrow \sigma_{A,B} & & \nearrow \sigma_{B,A} \\
 & B \otimes A &
 \end{array}$$

[SMC.4] For each object $A \in \mathbb{X}$, the following diagram, called the **symmetry unit trian-**

gle commutes:

$$\begin{array}{ccc}
 A \otimes K & \xrightarrow{\sigma_{A,K}} & K \otimes A \\
 & \searrow \rho_A & \swarrow \lambda_A \\
 & A &
 \end{array}$$

[SMC.5] For all objects $A, B, C, D \in \mathbb{X}$, the following diagram, called the **symmetry associativity hexagon**, commutes:

$$\begin{array}{ccccc}
 A \otimes (B \otimes C) & \xrightarrow{\alpha_{A,B,C}} & (A \otimes B) \otimes C & \xrightarrow{\sigma_{A \otimes B, C}} & C \otimes (A \otimes B) \\
 \downarrow 1_A \otimes \sigma_{B,C} & & & & \downarrow \alpha_{C,A,B} \\
 A \otimes (C \otimes B) & \xrightarrow{\alpha_{A,C,B}} & (A \otimes C) \otimes B & \xrightarrow{\sigma_{A,C} \otimes 1_B} & (C \otimes A) \otimes B
 \end{array}$$

As stated in the introduction of this chapter, we will assume that all symmetric monoidal categories in this thesis are strictly associative. Strictly associative implies that the associativity isomorphism α is in fact the identity. Explicitly, this means that for each triple of objects:

$$A \otimes B \otimes C = A \otimes (B \otimes C) = (A \otimes B) \otimes C$$

Therefore, we will suppress α from the definition of symmetric monoidal categories. The notation we will be using for a symmetric monoidal category is the sextuple $(\mathbb{X}, \otimes, K, \lambda, \rho, \sigma)$ where \mathbb{X} is the category, \otimes is the tensor product, K is the unit, λ and ρ are the left and right unit isomorphisms respectively and σ is the symmetry isomorphism.

Examples of symmetric monoidal categories will be given after the definition of additive symmetric monoidal categories. In particular, Examples 2.3 and 2.4 illustrate the symmetric monoidal structure of the category sets and relations and the category of vector spaces, respectively.

Next we recall the definition of an additive symmetric monoidal category and provide

two main examples. It should be noted that our definition of an additive category is different than that found in other sources (such [29]) because we will only require commutative monoid enrichment instead of abelian group enrichment. In particular, this means we are not assuming that the hom-sets have additive inverses, that is, negatives. This allows us to study many additional examples such as the category of sets and relation [29] and the category of modules over a rig (semiring) [20]. Another point of difference from other references is that we do not require our additive categories to have biproducts (as with semi-additive categories [29]).

Definition 2.2. An **additive category** [8] is a commutative monoid enriched category, i.e, a category \mathbb{X} such that:

(i) For each pair of objects $A, B \in \mathbb{X}$, the hom-set $\mathbb{X}(A, B)$ is a commutative monoid with:

- (a) Binary operation $+$: $\mathbb{X}(A, B) \times \mathbb{X}(A, B) \rightarrow \mathbb{X}(A, B)$ called **addition**;
- (b) Unit $0_{A,B} : A \rightarrow B$ called the **zero map** (where we often simply write 0 when there is no confusion).

(ii) For all maps in \mathbb{X} , composition preserves the additive structure, that is:

- (a) $k(f + g) = kf + kg$;
- (b) $0f = 0$;
- (c) $(f + g)h = fh + gh$;
- (d) $f0 = 0$.

An **additive symmetric monoidal category** [8] is commutative monoid enriched symmetric monoidal category, i.e, a symmetric monoidal category $(\mathbb{X}, \otimes, K, \lambda, \rho, \sigma)$ where \mathbb{X} is an additive category and the monoidal product \otimes preserves the additive structure, that is:

- 1. $(f + g) \otimes h = f \otimes h + g \otimes h$;
- 2. $0 \otimes h = 0$;
- 3. $k \otimes (f + g) = k \otimes f + k \otimes g$;
- 4. $h \otimes 0 = 0$.

In any additive category, we can define the notion of scalar multiplication. For any map $f : A \rightarrow B$ and any natural number $n \in \mathbb{N}$, define the map $n \cdot f : A \rightarrow B$ as follows:

$$n \cdot f := \begin{cases} \underbrace{f + \dots + f}_{n\text{-times}} & \text{if } n \geq 1 \\ 0_{A,B} & \text{if } n = 0 \end{cases}$$

Furthermore, for every object $A \in \mathbb{X}$ and for every natural number $n \in \mathbb{N}$, define the map $n_A : A \rightarrow A$ as follows:

$$n_A = n \cdot 1_A$$

which also gives the following equality for every map $f : A \rightarrow B$:

$$n_A f = n \cdot f = f n_B$$

Notice this implies that n_A commutes (with respect to composition) with all endomorphism $f : A \rightarrow A$.

Similarly, in an additive symmetric monoidal category, for every pair of maps f and g and for any natural number $n \in \mathbb{N}$, we have the following equality:

$$(n \cdot f) \otimes g = n \cdot (f \otimes g) = f \otimes (n \cdot g)$$

In particular, this implies that the tensor product \otimes for additive symmetric monoidal categories behaves as the standard product tensor product for vector spaces but where the scalars are taken to be the natural numbers.

We will now give the two main examples of additive symmetric monoidal categories that will be used throughout this thesis: the category of vector spaces and the category of sets

and relation. We will illustrate these examples by listing in detail the additive symmetric monoidal structure. However, we will not prove that these examples are in fact additive symmetric monoidal categories as the proofs are routine but tedious.

Example 2.3. Recall that a relation R from a set X to a set Y is a subset of $X \times Y$. Sets as objects, and relations as maps form a category called the category of sets and relations, \mathbf{REL} (see [29, 3] for more details on this category). In this context, a relation $R \subseteq X \times Y$ is expressed as the map $R : X \rightarrow Y$. The category of sets and relations, \mathbf{REL} , is an additive symmetric monoidal category where:

(i) The symmetric monoidal structure $(\mathbf{REL}, \times, \{*\}, \pi_0, \pi_1, \sigma^\times)$ is given by the standard cartesian product of sets \times where:

(a) The unit is a chosen singleton set $\{*\}$;

(b) The left unit $\pi_0 : \{*\} \times X \rightarrow X$ is the left projection relation:

$$\pi_0 = \{((*, x), x) \mid x \in X\} \subseteq (\{*\} \times X) \times X$$

(c) The right unit $\pi_1 : X \times \{*\} \rightarrow X$ is the right projection relation:

$$\pi_1 = \{((x, *), x) \mid x \in X\} \subseteq (X \times \{*\}) \times X$$

(d) The symmetry isomorphism is the symmetric relation:

$$\sigma_{X,Y}^\times = \{((x, y), (y, x)) \mid x \in X, y \in Y\} \subseteq (X \times Y) \times (Y \times X)$$

(ii) The additive structure is given by the standard union of sets \cup where:

(a) The addition of a parallel pair of relations $R, S : X \rightrightarrows Y$ is their union:

$$R + S := R \cup S \subseteq X \times Y$$

(b) The zero map $0_{X,Y} : X \rightarrow Y$ between two sets is the empty subset:

$$0_{X,Y} := \emptyset \subset X \times Y$$

Example 2.4. The category of vector spaces over a field \mathbb{K} , $\mathbf{VEC}_{\mathbb{K}}$ (see [29, 12] for more details on this category), is an additive symmetric monoidal category where:

(i) The symmetric monoidal structure $(\mathbf{VEC}_{\mathbb{K}}, \otimes_{\mathbb{K}}, \mathbb{K}, \lambda, \rho, \sigma)$ is given by the standard tensor product of vector spaces (see Chapter XVI in [28] for more details) where:

- (a) The unit is the field \mathbb{K} as a vector space over itself;
- (b) The left unit $\lambda_V : \mathbb{K} \otimes_{\mathbb{K}} V \rightarrow V$ is the standard unique linear isomorphism;
- (c) The right unit $\rho_V : V \otimes_{\mathbb{K}} \mathbb{K} \rightarrow V$ is the standard unique linear isomorphism;
- (d) The symmetry isomorphism $\sigma_{V,W} : V \otimes_{\mathbb{K}} W \rightarrow W \otimes_{\mathbb{K}} V$ is the standard unique symmetry isomorphism.

(ii) The additive structure is given by the standard addition operation in vector spaces:

- (a) The addition of a parallel pair of linear maps $T, S : V \rightrightarrows W$ is the standard sum of linear maps $T + S : V \rightarrow W$;
- (b) The zero maps $0_{V,W} : V \rightarrow W$ between two vector spaces is the standard linear map which maps every element of V to the zero element of W .

2.2 Coalgebra Modality

In this section we recall the definition of a coalgebra modality. Coalgebra modalities usually arise from categories which are models of linear logic [5, 31, 34], however these require much more structure than what we require for integral and differential categories. Instead, we will take the approach taken in [8, 34] which define coalgebra modalities on symmetric monoidal

categories. While it is true that the dual of coalgebra modalities, algebra modalities, are much more intuitive, we chose to work with coalgebra modalities as they were originally used in the introduction of differential categories [8]. We begin this section by recalling the definition of a comonad and then give the definition of a coalgebra modality. We finish this section by giving the two main examples of coalgebra modalities which in turn will be part of our main examples of differential and integral categories.

Monads are possibly more familiar as they arise most commonly from the notion of freeness (such as the free group or free monoid over a set [28, 29]). Comonads are simply the dual notion. In particular, both arise from adjunctions [29] (which we will not discuss here). Since we are interested in working with coalgebra modalities, we will give the definition of a comonad below and direct the reader to the definition of a monad in another source such as [29].

Definition 2.5. A **comonad** [29] on a category \mathbb{X} is a triple $(!, \delta, \varepsilon)$ consisting of:

- (i) An endofunctor $! : \mathbb{X} \rightarrow \mathbb{X}$;
- (ii) A natural transformation δ , with components $\delta_A : !A \rightarrow !!A$;
- (iii) A natural transformation ε , with components $\varepsilon_A : !A \rightarrow A$.

In addition, for every object $A \in \mathbb{X}$ the following diagrams commute:

$$\begin{array}{ccc}
 !A & \xrightarrow{\delta_A} & !!A \\
 \delta_A \downarrow & \searrow & \downarrow \varepsilon_{!A} \\
 !!A & \xrightarrow{!(\varepsilon_A)} & !A
 \end{array}
 \qquad
 \begin{array}{ccc}
 !A & \xrightarrow{\delta_A} & !!A \\
 \delta_A \downarrow & & \downarrow \delta_{!A} \\
 !!A & \xrightarrow{!(\delta_A)} & !!!A
 \end{array}$$

From a comonad $(!, \varepsilon, \delta)$ on category \mathbb{X} , one can define a new category, called its coKleisli category [29], whose objects are the same as \mathbb{X} but whose maps are of the form $f : !A \rightarrow B$. As discussed in the introduction of [8], the coKleisli category for a comonad $(!, \varepsilon, \delta)$ of a differential category should be thought of as the category of differentiable (or smooth) functions

of the base category. Maps of the base category should be thought of as linear maps, which are of course also smooth functions. More explicitly, for a category with a comonad $(!, \varepsilon, \delta)$, a smooth map from A to B is a map of the form $f : !A \rightarrow B$ (i.e. a map in the coKleisli category), while standard maps $g : A \rightarrow B$ are linear maps, which can be interpreted as the smooth maps $\varepsilon_{Ag} : !A \rightarrow B$. In the next chapter, we will use a similar intuition for integration.

We will provide examples of comonads after giving the definition of coalgebra modalities below. In particular, Examples 2.8 and 2.9 illustrate examples of comonads, which are also coalgebra modalities, on our two main examples of additive symmetric monoidal category. An important source of examples of comonads are monads for the opposite category. This will be used in particular for the category of vector spaces, as seen in Example 2.9.

Coalgebra modalities are comonads which come equipped with a comultiplication and a counit. Again, the comultiplication and counit are simply the dual notions of the multiplication and unit for a monoid or algebra. We give the definition of a coalgebra modality below and give our two main examples afterwards.

Definition 2.6. A **(cocommutative) coalgebra modality** [8, 9] on a symmetric monoidal category $(\mathbb{X}, \otimes, K, \lambda, \rho, \sigma)$ is a quintuple $(!, \delta, \varepsilon, \Delta, e)$ consisting of:

- (i) An endofunctor $! : \mathbb{X} \rightarrow \mathbb{X}$;
- (ii) A natural transformation δ , with components $\delta_A : !A \rightarrow !!A$;
- (iii) A natural transformation ε , with components $\varepsilon_A : !A \rightarrow A$;
- (iv) A natural transformation Δ , with components $\Delta_A : !A \rightarrow !A \otimes !A$, called the comultiplication;
- (v) A natural transformation e , with components $e_A : !A \rightarrow K$, called the counit.

In addition, the following must be satisfied:

1. $(!, \delta, \varepsilon)$ is a comonad;
2. For each object $A \in Ob(\mathbb{X})$, $(!A, \Delta_A, e_A)$ is a cocommutative comonoid, that is, the following diagrams commute:

$$\begin{array}{ccc}
 !A & \xrightarrow{\Delta} & !A \otimes !A \\
 \Delta \downarrow & & \downarrow \Delta \otimes 1 \\
 !A \otimes !A & \xrightarrow{1 \otimes \Delta} & !A \otimes !A \otimes !A
 \end{array}
 \qquad
 \begin{array}{ccccc}
 & & !A & & \\
 & \swarrow \lambda^{-1} & \downarrow \Delta & \searrow \rho^{-1} & \\
 K \otimes !A & \xleftarrow{e \otimes 1} & !A \otimes !A & \xrightarrow{1 \otimes e} & !A \otimes K
 \end{array}$$

$$\begin{array}{ccc}
 !A & \xrightarrow{\Delta} & !A \otimes !A \\
 & \searrow \Delta & \downarrow \sigma \\
 & & !A \otimes !A
 \end{array}$$

3. For each object $A \in Ob(\mathbb{X})$, δ_A preserves the comultiplication, that is, the following diagram commutes:

$$\begin{array}{ccc}
 !A & \xrightarrow{\delta_A} & !!A \\
 \Delta_A \downarrow & & \downarrow \Delta_{!A} \\
 !A \otimes !A & \xrightarrow{\delta_A \otimes \delta_A} & !!A \otimes !!A
 \end{array}$$

Requiring that Δ and e be natural transformations is equivalent to asking that for each map $f : A \rightarrow B$ of \mathbb{X} , $!(f) : !A \rightarrow !B$ is a coalgebra morphism, that is, the following diagrams commute:

$$\begin{array}{ccc}
 !A & \xrightarrow{\Delta} & !A \otimes !A \\
 !(f) \downarrow & & \downarrow !(f) \otimes !(f) \\
 !B & \xrightarrow{\Delta} & !B \otimes !B
 \end{array}
 \qquad
 \begin{array}{ccc}
 !A & \xrightarrow{!(f)} & !B \\
 & \searrow e & \downarrow e \\
 & & K
 \end{array}$$

Similarly, one can prove that for each object A , δ_A also preserves the counit and therefore is in fact a coalgebra morphism.

Proposition 2.7. *Let $(\mathbb{X}, \otimes, K, \lambda, \rho, \sigma)$ be a symmetric monoidal category with a coalgebra modality $(!, \delta, \varepsilon, \Delta, e)$. Then for each object $A \in Ob(\mathbb{X})$, δ_A is a coalgebra morphism.*

Proof. By definition of being a coalgebra modality, for all objects A , δ_A preserves the multiplication. Therefore it remains to show that for each object A , δ_A also preserves the counit e_A . By the above remark, for every map f , $!(f)$ is a coalgebra morphism. In particular, $!(f)$ preserves the counit e . Therefore, since $!(\varepsilon_A)$ is a coalgebra morphism and $(!, \delta, \varepsilon)$ is a comonad, we have the following equality:

$$\delta_A e_{!A} = \delta_A !(\varepsilon_A) e_A = e_A$$

□

We will now give the two main examples of coalgebra modalities that will be used throughout this thesis: the free symmetric algebra monad on the opposite category of vector spaces and the finite bag comonad on the category of sets and relation. We will illustrate these examples by listing in detail the coalgebra modality. However, we will not prove that these examples are in fact coalgebra modalities as the proofs are routine but lengthy and appear in [8].

Example 2.8. The category of sets and relations, \mathbf{REL} , has a coalgebra modality $(!, \delta, \varepsilon, \Delta, e)$ given by the finite bag comonad [8] where:

- (i) The endofunctor $! : \mathbf{REL} \rightarrow \mathbf{REL}$ maps a set X to the cofree comonoid over X , or equivalently, the set of all finite bags of X (including the empty bag), that is, on objects the functor $!$ is defined as follows:

$$!(X) = \{ \llbracket x_1, \dots, x_n \rrbracket \mid x_i \in X \}$$

while for relation $R : X \rightarrow Y$, $!(R) : !X \rightarrow !Y$ is the relation which relates a bag of X to a bag of Y of the same size and such that the elements of the bags are related by R :

$$!(R) = \{ (\llbracket x_1, \dots, x_n \rrbracket, \llbracket y_1, \dots, y_n \rrbracket) \mid (x_i, y_i) \in R \} \subset !(X) \times !(Y)$$

(ii) The comonad counit $\varepsilon_X : !(X) \rightarrow X$ is the relation which relates one element bags to their element in X :

$$\varepsilon_X = \{([\![x]\!], x) \mid x \in X\} \subset !(X) \times X$$

(iii) The comonad comultiplication $\delta_X : !(X) \rightarrow !(!(X))$ is the relation which relates a bag to the bag of all possible bag splittings of the original bag:

$$\delta_X = \{(B, [\![B_1, \dots, B_n]\!]) \mid B, B_i \in !(X), B_1 \cup \dots \cup B_n = B\} \subseteq !(X) \times !(!(X))$$

(iv) The comultiplication $\Delta_X : !(X) \rightarrow !(X) \times !(X)$ is the relation which relates a bag to the pair of all possible two bag splittings of the original bag:

$$\Delta_X = \{(B, (B_1, B_2)) \mid B, B_i \in !(X), B_1 \cup B_2 = B\} \subseteq !(X) \times (!(X) \times !(X))$$

(v) The counit $e_X : !(X) \rightarrow \{*\}$ is the relation which relates the empty bag to the single element $*$:

$$u_X = \{(\emptyset, *)\} \subset !(X) \times \{*\}$$

Example 2.9. The category of vector spaces over a field \mathbb{K} , $\text{VEC}_{\mathbb{K}}$, has an **algebra modality** (that is, $\text{VEC}_{\mathbb{K}}^{Op}$ has a coalgebra modality) $(\text{Sym}, \eta, \mu, \nabla, u)$ given by the **free symmetric algebra monad** [29] where:

(i) The functor $\text{Sym} : \text{VEC}_{\mathbb{K}} \rightarrow \text{VEC}_{\mathbb{K}}$ maps a vector space V to the free commutative algebra over V which is also known as the symmetric algebra over V (see Section 8, Chapter XVI in [28] for more details):

$$\text{Sym}(V) = \bigoplus_{n=0}^{\infty} \text{Sym}^n(V) = \mathbb{K} \oplus V \oplus \text{Sym}^2(V) \oplus \dots$$

where $\text{Sym}^n(V)$ is simply the quotient of $V^{\otimes n}$ by the tensor symmetry equalities:

$$v_1 \otimes \dots \otimes v_i \otimes \dots \otimes v_n = v_{\sigma(1)} \otimes \dots \otimes v_{\sigma(i)} \otimes \dots \otimes v_{\sigma(n)}$$

For a linear transformation $T : V \rightarrow W$, $\text{Sym}(T) : \text{Sym}(V) \rightarrow \text{Sym}(W)$ is defined on pure tensors by applying T to each component:

$$\text{Sym}(T)(v_1 \otimes \dots \otimes v_n) = T(v_1) \otimes \dots \otimes T(v_n)$$

which we then extend by linearity.

(ii) The monad unit $\eta_V : V \rightarrow \text{Sym}(V)$ is the injection map of V into $\text{Sym}(V)$:

$$\eta_V(v) = v$$

(iii) The monad multiplication $\mu_V : \text{Sym}(\text{Sym}(V)) \rightarrow \text{Sym}(V)$ on pure tensors simply removes the brackets and concatenates words together:

$$\mu_V([a_{1,1} \otimes \dots \otimes a_{1,n}] \otimes \dots \otimes [a_{i,1} \otimes \dots \otimes a_{i,m}]) = a_{1,1} \otimes \dots \otimes a_{1,n} \otimes \dots \otimes a_{i,1} \otimes \dots \otimes a_{i,m}$$

which we then extend by linearity.

(iv) The multiplication $\nabla_V : \text{Sym}(V) \otimes \text{Sym}(V) \rightarrow \text{Sym}(V)$ is concatenation of words:

$$\nabla_V(v_1 \otimes \dots \otimes v_n, w_1 \otimes \dots \otimes w_m) = v_1 \otimes \dots \otimes v_n \otimes w_1 \otimes \dots \otimes w_m$$

which we then extend by linearity.

(v) The unit $u_V : \mathbb{K} \rightarrow \text{Sym}(V)$ is the injection map of \mathbb{K} into $\text{Sym}(V)$:

$$u_V(1) = 1$$

which we then extend by linearity.

2.3 Graphical Calculus

Additive symmetric monoidal categories have a graphical calculus which allows us to express algebraic equations as string diagrams. This graphical calculus is extremely useful when dealing with proofs which would require lengthy and complicated algebraic calculations. The main concept of the graphical calculus is that it is a form of representations of maps and composition in a monoidal category using string diagrams. We can manipulate and concatenate string diagrams according to the axiom of additive symmetric monoidal categories and the extra structure on them such as coalgebra modalities. For a simple example, consider the following string diagram which represents the composite map fg which illustrates the idea of first doing f then g :

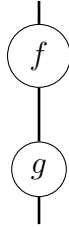

In this thesis, string diagrams are to be read from top to bottom.

Proofs are much easier to understand and read if we use string diagrams. On top of this, proofs done in the graphical calculus are equivalent to proofs done algebraically, as shown in [24]. While we won't give an introduction to the functionality of the graphical calculus, we will instead give a table for all the symbols we will use in our graphical calculus, Table 2.3. We refer the reader to [33] for an introduction to the graphical calculus in monoidal categories and its variations.

String Diagram	Description	String Diagram	Description
	A circle will be used for maps f		A triangle will be used for the comultiplication
	Nothing between strings will be used to denote $f \otimes g$		A e in a circle with no string coming out will represent the counit for the comultiplication.
	A + between strings will be used to denote $f + g$		A line will be used for the integrating transformation (Definition 3.9)
	A square will be used for maps $!(f)$		A double line in this direction will be used for the coderiving transformation (Definition 6.1)
	Two lines which twist by overlapping will be used for the symmetry isomorphism σ		A double line in this direction will be used for the deriving transformation (Definition 4.5)

Table 2.1: Graphical Calculus Reference

For an example of how we use and read string diagrams, consider the expression of the axioms of a coalgebra modality in the graphical calculus notation:

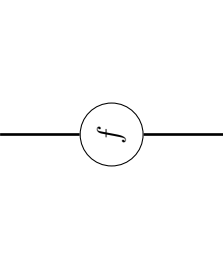
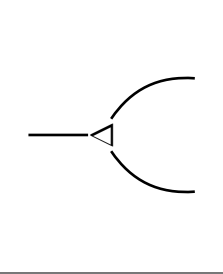
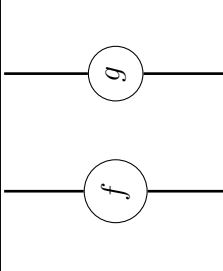
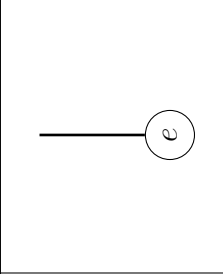
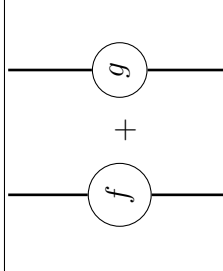
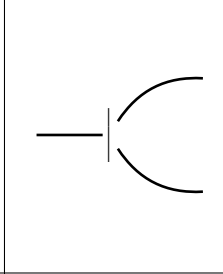
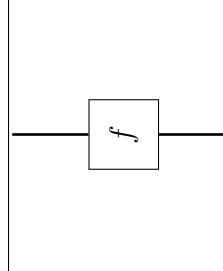
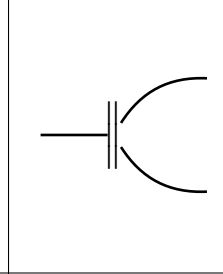
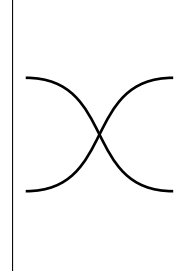
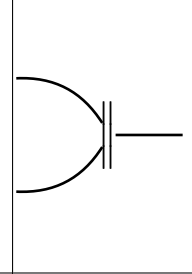
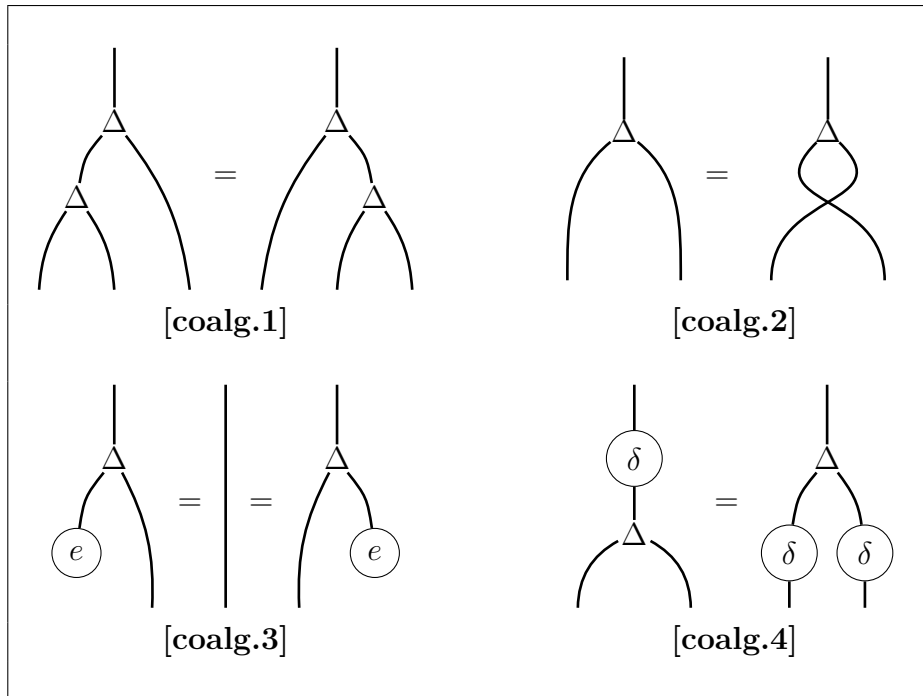

Table 2.2: Coalgebra Modality Properties in String Diagrams

Where **[coalg.1]** represents the coassociativity of the comultiplication, **[coalg.2]** is the cocommutativity of the comultiplication, **[coalg.3]** is the left and right counit laws and **[coalg.4]** is that δ preserves the comultiplication.

Chapter 3

Integral Categories

In this chapter we introduce integral categories, give examples of integral categories, and study the basic properties of integral categories. We begin by defining an integral combinator, which is the key ingredient of an integral category. Afterwards, we provide a short discussion on the naturality of the combinator. This discussion leads to introducing the integral transformation. One then obtains an equivalent definition of an integral category in terms of the integral transformation. We can then introduce the graphical calculus for integral categories. While having two different ways of illustrating a concept is always important, there is a reason why we wish to have both. The combinator description of the integral category structure is more intuitive while the transformation description is much more practical (in particular for examples and calculations). For this reason, we give both definitions and prove the equivalence between an integral combinator and an integral transformation. This way of introducing integral categories mirrors precisely the way differential categories were originally introduced in [8].

We then give our two main examples of integral categories: the category of vector spaces and the category of sets and relations. Finally, in the last two sections of this chapter we explore some of the basic and important properties of integration that one obtains in an

integral category. We first study polynomial integration in an integral category and how this implies non-negative rationals in an integral category. Then we study other interesting properties of integration: two coming from classical calculus and one from the theory of Rota-Baxter algebras and modules [21]. We finish this chapter with a brief discussion of the interpretation of Fubini's theorem in integral categories.

3.1 Integral Combinator

An integral category is an additive symmetric monoidal category with a coalgebra modality and an integral combinator. An integral combinator is an operator on certain maps, called integrable, where the resulting map is the integral of the input map. After giving the definition, we will give some intuition for the combinator and the axioms that it must satisfy. We begin by giving the definition of a combinator:

Definition 3.1. Let \mathbb{X} be a category and let F, G, F' and G' be four endofunctors from \mathbb{X} to \mathbb{X} . A **combinator** C of F, G, F' and G' is a family of set functions indexed by pairs of objects of \mathbb{X} on the following hom-sets of \mathbb{X} :

$$C = \{C_{A,B} : \mathbb{X}(F(A), G(B)) \rightarrow \mathbb{X}(F'(A), G'(B)) \mid A, B \in Ob(\mathbb{X})\}$$

We will often simply write $C : \mathbb{X}(F(A), G(B)) \rightarrow \mathbb{X}(F'(A), G'(B))$ when there is no confusion.

Application of the combinator will be written out as follows:

$$\frac{f : F(A) \rightarrow G(B)}{C[f] : F'(A) \rightarrow G'(B)} C$$

Two simple examples of combinators are functors and natural transformations:

Example 3.2. Every endofunctor $F : \mathbb{X} \rightarrow \mathbb{X}$ induces a combinator of the identity functor $1_{\mathbb{X}}$ and F itself by applying the functor, that is, F is a combinator of the functors $1_{\mathbb{X}}, 1_{\mathbb{X}}, F$

and F :

$$\frac{f : A \rightarrow B}{F(f) : F(A) \rightarrow G(B)} F$$

Example 3.3. Every natural transformation $\eta : F \rightarrow G$ between a pair of endofunctors $F, G : \mathbb{X} \rightarrow \mathbb{X}$ induces a combinator of the identity functor $1_{\mathbb{X}}$, F and G by pre-composition, that is, η is a combinator of the functors $G, 1_{\mathbb{X}}, F$ and $1_{\mathbb{X}}$:

$$\frac{f : G(A) \rightarrow B}{\eta_A f : F(A) \rightarrow B} \eta$$

similarly η is a combinator of the functors $1_{\mathbb{X}}, F, 1_{\mathbb{X}}$ and G by post-composition.

It should be noted that not all combinators need to be functors, as seen with the integral combinator below, or natural transformations, as seen with the differential combinator in a cartesian differential category [10]. Now we introduce the definition of an integral combinator.

Definition 3.4. Let $(\mathbb{X}, \otimes, K, \lambda, \rho, \sigma)$ be an additive symmetric monoidal category with a coalgebra modality $(!, \delta, \varepsilon, \Delta, e)$. An **integral combinator** S on $(!, \delta, \varepsilon, \Delta, e)$ is a combinator of the functors $!(-) \otimes -, 1_{\mathbb{X}}, !$ and $1_{\mathbb{X}}$:

$$\frac{f : !A \otimes A \rightarrow B}{S[f] : !A \rightarrow B} S$$

such that S satisfies the following properties:

[S.A] Additivity: For any pair of parallel maps $f, g : !A \otimes A \rightrightarrows B$, the following equality holds:

$$S[f + g] = S[f] + S[g]$$

[S.N] Naturality/Linear Substitution: If the square on the left commutes, then the square

on the right commutes:

$$\begin{array}{ccc}
 !A \otimes A & \xrightarrow{f} & B \\
 !h \otimes h \downarrow & & \downarrow k \\
 !C \otimes C & \xrightarrow{g} & D
 \end{array}
 \Rightarrow
 \begin{array}{ccc}
 !A & \xrightarrow{S[f]} & B \\
 !h \downarrow & & \downarrow k \\
 !C & \xrightarrow{S[g]} & D
 \end{array}$$

[S.1] Integral of Constants Rule: For every object A , the following equality holds:

$$S[(e_A \otimes 1_A)\lambda_A] = \varepsilon_A$$

[S.2] Rota-Baxter Rule: For any pair of maps $f : !A \otimes A \rightarrow B$ and $g : !A \otimes A \rightarrow C$, the following equality holds:

$$\Delta_A(S[f] \otimes S[g]) = S[(\Delta_A \otimes 1_A)(S[f] \otimes g)] + S[(\Delta_A \otimes 1_A)(1_{!A} \otimes \sigma)(f \otimes S[g])]$$

[S.3] Independence Rule: For every map $f : !A \rightarrow B$, the following equality holds:

$$S[S[f \otimes 1_A] \otimes 1_A] = S[(S[f \otimes 1_A] \otimes 1_A)(1_B \otimes \sigma_{A,A})]$$

Definition 3.5. An **integral category** is an additive symmetric monoidal category with a coalgebra modality and an integral combinator. In an integral category, we say a map is **integrable** if it is of the form $f : !A \otimes A \rightarrow B$ and that the **integral** of f is the map $S[f] : !A \rightarrow B$.

It might be useful for the reader to have some intuition regarding integral combinators, integrable maps and the axioms. The integral of $f : !A \otimes A \rightarrow B$, $S[f] : !A \rightarrow B$ should be thought of as the classical integral of f evaluated from zero to x as a function of x :

$$S[f](x) := \int_0^x f(t) dt$$

To interpret this as $S[f]$ one must regard f as being a function of two variables: t , which is the $!A$ part of the domain, and dt , which is linear in dt which is the A part of the domain. Classically, f is regarded as a function of one (one dimensional) variable, t , and to obtain our interpretation as a function of two arguments one simply multiplies by the variable dt . This allows a simple interpretation of the integral notation for one dimensional functions: it leaves open the interpretation for multidimensional functions – an issue to which we shall return to later, in particular in the example of the category of vector spaces.

The first axiom **[S.A]** simply formalizes the fact that the integral of a sum of functions is the sum of each integral:

$$S[f + g] = \int_0^x (f(t) + g(t)) dt = \int_0^x f(t) dt + \int_0^x g(t) dt = S[f] + S[g] \quad \text{[S.A]}$$

The second axiom **[S.N]** is a naturality condition with respect to linear maps which amounts to saying that the integral preserves linear substitution. To preserve linear substitution means that if h and k are linear functions and $k(f(x)) dt = g(h(t)) d(h(t))$ then:

$$!(h)S[g] = \int_0^{h(x)} g(t) dt = k\left(\int_0^x f(t) dt\right) = S[f]k$$

This naturality condition may become clearer in the next section where we will split this axiom into two smaller axioms. The next axiom **[S.1]** asks our integral combinator to satisfy that the integral of the constant function 1, or simply dt , is the linear function x (which is not the standard identity but rather the identity in the coKleisli category):

$$S[(e \otimes 1)\lambda] = \int_0^x 1 dt = \int_0^x dt = x = \varepsilon \quad \text{[S.1]}$$

The next axiom **[S.2]** is the so called Rota-Baxter rule, as discussed in our introduction.

This is the fundamental axiom of our integral combinator.

$$\begin{aligned}
\Delta(\mathbf{S}[f] \otimes \mathbf{S}[g]) &= \int_0^x f(t) \, dt \cdot \int_0^x g(t) \, dt \\
&= \int_0^x \left(\int_0^t f(u) \, du \right) \cdot g(t) \, dt + \int_0^x f(t) \cdot \left(\int_0^t g(u) \, du \right) \, dt \\
&= \mathbf{S}[(\Delta \otimes 1)(\mathbf{S}[f] \otimes g)] + \mathbf{S}[(\Delta \otimes 1)(1 \otimes \sigma)(f \otimes \mathbf{S}[g])] \quad \mathbf{[S.2]}
\end{aligned}$$

Here the comultiplication Δ is interpreted as multiplication, represented by \cdot , while the symmetry map σ in the second part of the sum is there to place the dt at the end of integral, just as in classical calculus.

Finally the last axiom **[S.3]** gives the independence of the order of integration: the interchange law, that is, integrating with respect to u then t is the same as integrating with respect to t then u . This is closely related to Fubini's theorem, but is not actually Fubini's theorem as we will discuss in Section 3.7. This is more of a one dimensional Fubini's theorem. This identity can be expressed in classical notation as:

$$\mathbf{S}[\mathbf{S}[f \otimes 1_A] \otimes 1_A] = \int_0^x \left(\int_0^t f(u) \, du \, dt \right) = \int_0^x \left(\int_0^u f(t) \, dt \, du \right) = \mathbf{S}[(\mathbf{S}[f \otimes 1_A] \otimes 1_A)(1_B \otimes \sigma_{A,A})] \quad \mathbf{[S.3]}$$

This may seem like a trivial change of variable but recall that we are now considering dt and du as part of our function.

3.2 Naturality of the Integral Combinator

In this section, we explore the naturality axiom of our combinator **[S.N]** further. The naturality **[S.N]** of the combinator \mathbf{S} can be described in alternative way by splitting it into two:

[S.N.a] Left Linear Substitution: For every pair of maps $h : A \rightarrow C$ and $g : !(C) \otimes C \rightarrow B$,

the following equality holds:

$$S[!(h) \otimes h]g = !(h)S[g]$$

[S.N.b] Right Linear substitution: For every pair of maps $f : !A \otimes A \rightarrow B$ and $k : B \rightarrow D$, the following equality holds:

$$S[fk] = S[f]k$$

For intuition using classical calculus, the first of the two **[S.N.a]** says that if h is a linear function and if we let $u = h(t)$ then:

$$S[!(h) \otimes h]g = \int_0^x g(h(t)) \, d(h(t)) = \int_0^{h(x)} g(u) \, du = !(h)S[g] \quad \text{[S.N.a]}$$

The second **[S.N.b]** is similar and says that if k is a linear function then:

$$S[fk] = \int_0^x k(f(t)) \, dt = k\left(\int_0^x f(t) \, dt\right) = S[f]k \quad \text{[S.N.b]}$$

In the following proposition, we prove that these two axioms are indeed equivalent to the naturality axiom.

Proposition 3.6. *The following are equivalent:*

- (i) **[S.N]**;
- (ii) **[S.N.a]** and **[S.N.b]**.

Proof. $i) \Rightarrow ii)$: For **[S.N.a]**, notice that the square on the left commutes trivially and then by **[S.N]**, the square on the right commutes:

$$\begin{array}{ccc} !A \otimes A & \xrightarrow{!(h \otimes h)g} & D \\ !h \otimes h \downarrow & & \parallel \\ !C \otimes C & \xrightarrow{g} & D \end{array} \Rightarrow \begin{array}{ccc} !A & \xrightarrow{S[!(h) \otimes h]g} & D \\ !h \downarrow & & \parallel \\ !C & \xrightarrow{S[g]} & D \end{array}$$

Similarly for [S.N.b], notice that the square on the left commutes trivially and then by [S.N], the square on the right commutes:

$$\begin{array}{ccc} !A \otimes A & \xrightarrow{f} & B \\ \parallel & & \downarrow k \\ !A \otimes A & \xrightarrow{fk} & D \end{array} \Rightarrow \begin{array}{ccc} !A & \xrightarrow{S[f]} & B \\ \parallel & & \downarrow k \\ !A & \xrightarrow{S[fk]} & D \end{array}$$

ii) \Rightarrow i): Suppose that $(!h \otimes h)g = fk$ for the appropriate maps f, g, h and k . Then by [S.N.a] and [S.N.b], we have the following equality:

$$(!h \otimes h)S[g] = S[(!h \otimes h)f] = S[fk] = S[f]k$$

□

Naturality of the integral combinator S also implies that the integral of zero is zero.

Proposition 3.7. *In an integral category, the integral of zero is zero. Explicitly, let $(\mathbb{X}, \otimes, K, \lambda, \rho, \sigma)$ be an integral category with a coalgebra modality $(!, \delta, \varepsilon, \Delta, e)$ and an integral combinator S . Then S satisfies the following:*

[S.A.0] *Integral of zero:*

$$S[0_{!A \otimes A, B}] = 0_{!A, B}$$

For every pair of objects A and B in \mathbb{X} .

Proof. By the additive symmetric monoidal structure, the square on the left commutes and then by [S.N], the square on the right commutes:

$$\begin{array}{ccc} !A \otimes A & \xrightarrow{0} & B \\ \parallel & & \downarrow 0 \\ !A \otimes A & \xrightarrow{0} & B \end{array} \Rightarrow \begin{array}{ccc} !A & \xrightarrow{S[0]} & B \\ \parallel & & \downarrow 0 \\ !A & \xrightarrow{S[0]} & B \end{array}$$

However, by the additive symmetric monoidal structure, $!(0) \otimes 0 = 0$, and we get the following

equality:

$$S[0] = S[0]0 = 0$$

□

Naturality of the integral combinator also gives a general way of describing the integrals of maps. Notice by naturality of the integral combinator, since the square on the left commutes trivially for every integrable map then the square on the right commutes:

$$\begin{array}{ccc} !A \otimes A & \xrightarrow{1_{!A \otimes A}} & !A \otimes A \\ \parallel & & \downarrow f \\ !A \otimes A & \xrightarrow{f} & B \end{array} \Rightarrow \begin{array}{ccc} !A & \xrightarrow{S[1_{!A \otimes A}]} & !A \otimes A \\ \downarrow !(1_A) & & \downarrow f \\ !A & \xrightarrow{S[f]} & B \end{array}$$

Therefore, we get the following proposition:

Proposition 3.8. *Let $(\mathbb{X}, \otimes, K, \lambda, \rho, \sigma)$ be an integral category with a coalgebra modality $(!, \delta, \varepsilon, \Delta, e)$ and an integral combinator S . Then for every integrable map $f : !A \otimes A \rightarrow B$:*

$$S[f] = S[1_{!A \otimes A}]f$$

If we define $s_A = S[1_{!A \otimes A}] : !A \rightarrow !A \otimes A$, then by the above proposition:

$$S[f] = s_A f$$

for every integrable map $f : !A \otimes A \rightarrow B$. In fact, the integral combinator S can be completely re-expressed in terms of s , which we discuss in the next section.

3.3 Integral Transformation

In this section we introduce the integral transformation. We will then be able to integrate maps by precomposing by the integral transformation. This is the analogue of the deriving

transformation in differential categories [8] and is obtained in a similar fashion through naturality of the combinator as discussed above, which will we see in Chapter 4.5. At the same time as we present the definition, we introduce the graphical calculus for the integral transformation and draw out the axioms in string diagram form. Afterwards in the following section, we will show that this is indeed equivalent to having an integral combinator.

Definition 3.9. Let $(\mathbb{X}, \otimes, K, \lambda, \rho, \sigma)$ be an additive symmetric monoidal category with a coalgebra modality $(!, \delta, \varepsilon, \Delta, e)$. An **integral transformation** is a natural transformation \mathbf{s} with components $\mathbf{s}_A : !A \rightarrow !A \otimes A$

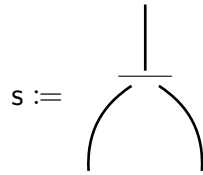

Such that for each object $A \in Ob(\mathbb{X})$, \mathbf{s}_A satisfies the following properties:

[s.1] Integral of Constants:

$$\mathbf{s}_A(e_A \otimes 1_A)\lambda_A = \varepsilon_A$$

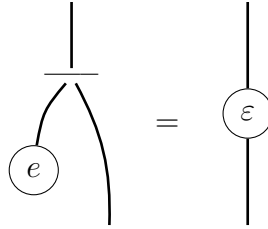

[s.2] Rota-Baxter Rule:

$$\Delta_A(\mathbf{s}_A \otimes \mathbf{s}_A) = \mathbf{s}_A(\Delta_A \otimes 1_A)(\mathbf{s}_A \otimes 1_{!A} \otimes 1_A) + \mathbf{s}_A(\Delta_A \otimes 1_A)(1_{!A} \otimes \sigma_{A,!A})(1_{!A} \otimes 1_A \otimes \mathbf{s}_A)$$

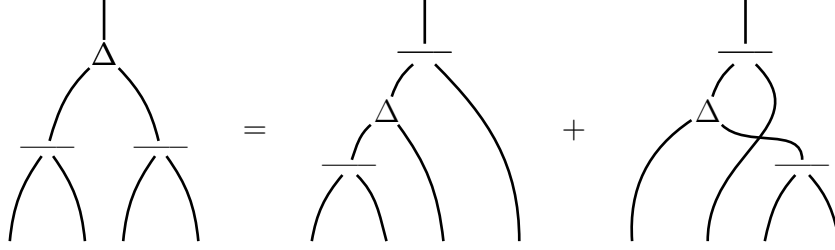

[s.3] Independence Rule:

$$s_A(s_A \otimes 1_A) = s_A(s_A \otimes 1_A)(1_{!A} \otimes \sigma_{A,A})$$

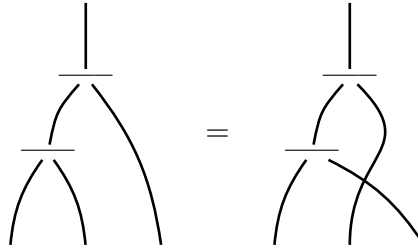

The axioms for the integral transformation are simple re-expressions of the axioms for the integral combinator.

The integral transformation gives an equivalent (and extremely useful) definition of an integral category, stated and proved in the following propositions. We begin by first proving that every integral combinator induces an integral transformation, then we prove the converse statement. Finally we end this section by proving that there is in fact a one to one correspondence between integral combinators and integral transformations.

The equational proofs in the following proposition are short and straightforward. Therefore, we will not use the graphical calculus here.

Proposition 3.10. *Let $(\mathbb{X}, \otimes, K, \lambda, \rho, \sigma)$ be an additive symmetric monoidal category with a coalgebra modality $(!, \delta, \varepsilon, \Delta, e)$ and an integral combinator S . Then S induces an integral transformation s whose components $s_A : !A \rightarrow !A \otimes A$ are defined as $s_A = S[1_{!A \otimes A}]$.*

Proof. Throughout this proof, we will make repeatedly use [S.N]. We first show naturality of \mathfrak{s} . Notice that for every map $f : A \rightarrow B$, the square on the left commutes trivially and so by [S.N], the square on the right commutes:

$$\begin{array}{ccc} !A \otimes A & \xlongequal{\quad} & !A \otimes A \\ !f \otimes f \downarrow & & \downarrow !f \otimes f \\ !B \otimes B & \xlongequal{\quad} & !B \otimes B \end{array} \Rightarrow \begin{array}{ccc} !A & \xrightarrow{S[1_{!A \otimes A}] = \mathfrak{s}_A} & !A \otimes A \\ !f \downarrow & & \downarrow !f \otimes f \\ !B \otimes B & \xrightarrow{S[1_{!B \otimes B}] = \mathfrak{s}_B} & !B \end{array}$$

The square on the right shows that \mathfrak{s} is a natural transformation.

Recall that we have also already shown that by [S.N], for every integrable map $f : !A \otimes A \rightarrow B$, $S[f] = S[1_{!A \otimes A}]f = \mathfrak{s}_A f$. With this identity, we can prove [s.1], [s.2] and [s.3].

[s.1] For the Integral of constants rule, we obtain the following equality by [S.1]:

$$\mathfrak{s}_A(e_A \otimes 1_A)\lambda_A = S[(e_A \otimes 1_A)\lambda_A] = \varepsilon_A$$

[s.2] For the Rota-Baxter rule, we obtain the following equality by [S.2]:

$$\begin{aligned} \Delta_A(\mathfrak{s}_A \otimes \mathfrak{s}_A) &= \Delta_A(S[1_{!A \otimes A}] \otimes S[1_{!A \otimes A}]) \\ &= S[(\Delta_A \otimes 1)(S[1_{!A \otimes A}] \otimes 1_{!A \otimes A})] + S[(\Delta_A \otimes 1)(1 \otimes \sigma)(1_{!A \otimes A} \otimes S[1_{!A \otimes A}])] \\ &= \mathfrak{s}_A(\Delta_A \otimes 1)(\mathfrak{s}_A \otimes 1 \otimes 1) + \mathfrak{s}_A(\Delta_A \otimes 1)(1 \otimes \sigma)(1 \otimes 1 \otimes \mathfrak{s}_A) \end{aligned}$$

[s.3] For the independence rule, we obtain the following equality by [S.3]:

$$\mathfrak{s}_A(\mathfrak{s}_A \otimes 1_A) = S[S[1_{!A} \otimes 1_A] \otimes 1_A] = S[(S[1_{!A} \otimes 1_A] \otimes 1_A)(1_{!A} \otimes \sigma_{A,A})] = \mathfrak{s}_A(\mathfrak{s}_A \otimes 1_A)(1_{!A} \otimes \sigma_{A,A})$$

□

Proposition 3.11. *Let $(\mathbb{X}, \otimes, K, \lambda, \rho, \sigma)$ be an additive symmetric monoidal category with a*

coalgebra modality $(!, \delta, \varepsilon, \Delta, e)$ and an integral transformation \mathfrak{s} . Then \mathfrak{s} induces an integral combinator \mathfrak{S} defined as:

$$\mathfrak{S}[f] = \mathfrak{s}_A f$$

For every map $f : !A \otimes A \rightarrow B$.

Proof. We must prove **[S.A]**, **[S.N]**, **[S.1]**, **[S.2]** and **[S.3]**:

[S.A] We obtain additivity of the combinator by the fact that composition preserves addition:

$$\mathfrak{S}[f + g] = \mathfrak{s}_A(f + g) = \mathfrak{s}_A f + \mathfrak{s}_A g = \mathfrak{S}[f] + \mathfrak{S}[g]$$

[S.N] For naturality, suppose that the following square commutes:

$$\begin{array}{ccc} !A \otimes A & \xrightarrow{f} & B \\ !h \otimes h \downarrow & & \downarrow k \\ !C \otimes C & \xrightarrow{g} & D \end{array}$$

Since \mathfrak{s} is a natural transformation, we obtain the following equality:

$$\mathfrak{S}[f]k = \mathfrak{s}_A f k = \mathfrak{s}_A(!h \otimes h)g = !h \mathfrak{s}_C g = !h \mathfrak{S}[g]$$

[S.1] For the Integral of constants rule, we obtain the following equality by **[s.1]**:

$$\mathfrak{S}[(e_A \otimes 1_A)\lambda_A] = \mathfrak{s}_A(e_A \otimes 1_A)\lambda_A = \varepsilon_A$$

[S.2] For the Rota-Baxter rule, we obtain the following equality by **[s.2]**:

$$\begin{aligned} \Delta_A(\mathfrak{S}[f] \otimes \mathfrak{S}[g]) &= \Delta_A(\mathfrak{s}_A \otimes \mathfrak{S}_A)(f \otimes g) \\ &= \mathfrak{s}_A(\Delta_A \otimes 1_A)(\mathfrak{s}_A \otimes 1_{!A} \otimes 1_A)(f \otimes g) + \mathfrak{s}_A(\Delta_A \otimes 1_A)(1_{!A} \otimes \sigma_{A,!A})(1_{!A} \otimes 1_A \otimes \mathfrak{s}_A)(f \otimes g) \\ &= \mathfrak{S}[(\Delta \otimes 1)(\mathfrak{S}[f] \otimes g)] + \mathfrak{S}[(\Delta \otimes 1)(1 \otimes \sigma)(f \otimes \mathfrak{S}[g])] \end{aligned}$$

[S.3] For the independence rule, we obtain the following equality by [s.3]:

$$\begin{aligned}
\mathsf{S}[\mathsf{S}[f \otimes 1_A] \otimes 1_A] &= \mathsf{s}_A(\mathsf{s}_A \otimes 1_A)(f \otimes 1_A \otimes 1_A) \\
&= \mathsf{s}_A(\mathsf{s}_A \otimes 1_A)(1_{!A} \otimes \sigma_{A,A})(f \otimes 1_A \otimes 1_A) \\
&= \mathsf{s}_A(\mathsf{s}_A \otimes 1_A)(f \otimes 1_A \otimes 1_A)(1_B \otimes \sigma_{A,A}) \\
&= \mathsf{S}[(\mathsf{S}[f \otimes 1_A] \otimes 1_A)(1_B \otimes \sigma)]
\end{aligned}$$

□

Proposition 3.12. *For an additive symmetric monoidal category $(\mathbb{X}, \otimes, K, \lambda, \rho, \sigma)$ with a coalgebra modality $(!, \delta, \varepsilon, \Delta, e)$, the set of integral combinators $\mathsf{IntComb}$ is isomorphic to the set of integral transformations $\mathsf{IntTran}$. The isomorphism is given by the following pair of inverse functions:*

$$\begin{aligned}
\psi : \mathsf{IntComb} &\longrightarrow \mathsf{IntTran} \\
\mathsf{S} &\longmapsto \psi(\mathsf{S})_A = \mathsf{S}[1_{!A \otimes A}] \\
\psi^{-1}(\mathsf{s})[f] &= \mathsf{s}f \longleftarrow \mathsf{s}
\end{aligned}$$

Therefore, the following are equivalent:

- (i) *An integral category;*
- (ii) *An additive symmetric monoidal category with a coalgebra modality and a integral transformation.*

Proof. Proposition 3.10 and Proposition 3.11 show that ψ and ψ^{-1} are well defined. Therefore it remains to show that these are isomorphism, inverse of each other. For both directions, let $f : !A \otimes A \rightarrow B$:

$$\psi^{-1}(\psi(\mathsf{S}))_A[f] = \psi(\mathsf{S})f \qquad \psi(\psi^{-1}(\mathsf{s})) = \psi^{-1}(\mathsf{s})[1_{!A} \otimes 1_A]$$

$$\begin{aligned}
&= S[1_{!A \otimes A}]f &&= s_A(1_{!A} \otimes 1_A) \\
&= S[f] &&= s_A
\end{aligned}$$

The equivalence follows directly. □

3.4 Main Examples of Integral Categories

Before exploring properties of integral category, we introduce our two main examples of integral categories. These two main examples will be used throughout these notes as in time we will also see that these are not only differential categories but also calculus categories. We will not prove that these examples are integral categories in this section; this will be done in Chapter 6. In fact we will see that the integral transformation given in these examples are induced by an anti-differential of the differential category structure. Thus, it makes more sense to provide some of the details and proofs after we establish differentiation in Chapter 4.

Example 3.13. The category of sets and relations, \mathbf{REL} , has an integral category structure where:

- (i) The additive symmetric monoidal structure $(\mathbf{REL}, \times, \{*\}, \pi_0, \pi_1, \sigma^\times)$ is the structure given in Example 2.3 from the Cartesian product of sets and union of sets;
- (ii) The coalgebra modality $(!, \delta, \varepsilon, \Delta, e)$ is the finite bag comonad given in Example 2.8;
- (iii) The integral transformation $s_X : !(X) \rightarrow !(X) \times X$ is the relation which relates a bag to a new bag where we pulled out an element of the original bag:

$$s_X = \{(B, (B - \{x\}, x)) \mid B \in !(X), x \in B\} \subseteq !(X) \times (!(X) \times X)$$

Proposition 3.14. *The category of sets and relations is an integral category with the struc-*

ture and integral transformation defined above.

Example 3.15. The category of vector spaces over a field \mathbb{K} of characteristic zero, $\mathbf{VEC}_{\mathbb{K}}$, has a co-integral category structure (that is, $\mathbf{VEC}_{\mathbb{K}}^{\text{Op}}$ is an integral category) where:

- (i) The additive symmetric monoidal structure $(\mathbf{VEC}_{\mathbb{K}}, \otimes_{\mathbb{K}}, \mathbb{K}, \lambda, \rho, \sigma)$ is the structure given in Example 2.4 from the standard tensor product of vector spaces and the standard additive structure of vector spaces;
- (ii) The algebra modality $(\mathbf{Sym}, \eta, \mu, \nabla, u)$ is given by the free symmetric algebra monad given in Example 2.9;
- (iii) The integral transformation $\mathfrak{s}_V : \mathbf{Sym}(V) \otimes V \rightarrow \mathbf{Sym}(V)$ on pure tensors is defined as follows:

$$\mathfrak{s}_V((v_1 \otimes \dots \otimes v_n) \otimes v) = \frac{1}{n+1} v_1 \otimes \dots \otimes v_n \otimes v$$

which we then extend by linearity.

An alternative approach of illustrating the integral category structure on $\mathbf{VEC}_{\mathbb{K}}$ is to make use of the isomorphism between the free symmetric algebra and the polynomial ring. Let $X = \{x_1, \dots\}$ be a basis of a vector space V . Then the free commutative algebra over V , $\mathbf{Sym}(V)$ is a \mathbb{K} -algebra isomorphic to the polynomial ring over X , $\mathbb{K}[X]$ [28]. Then the integral transformation can be described on the polynomial ring $\mathfrak{s}_V : \mathbb{K}[X] \otimes V \rightarrow \mathbb{K}[X]$ as follows on monomials and base elements:

$$\mathfrak{s}_V((x_1^{r_1} \dots x_n^{r_n}) \otimes x_i) = \frac{1}{1 + \sum_{j=1}^n r_j} x_1^{r_1} \dots x_i^{r_i+1} \dots x_n^{r_n}$$

At first glance this may seem a bit bizarre. One might expect the integral transformation to integrate a monomial with respect to the variable x_i and thus only multiply by $\frac{1}{1+r_i}$. However, this classical idea of integration fails the Rota-Baxter rule [s.2] for any vector space of dimension greater than one. This version of integration is the appropriate notion

of anti-differentiation on the differential structure associated to the free symmetric algebra monad, which we will see in Example 4.11.

Proposition 3.16. *The category of vector spaces over a fixed field of characteristic zero is a co-integral category with the structure and integral transformation defined above.*

3.5 Polynomial Integration and Rationals

In this section we examine polynomial integration in integral categories. Perhaps the first formula learned in first year calculus is the integral of monomials:

$$\int_0^x t^n dt = \frac{1}{n+1} x^{n+1}$$

However, we must re-express this identity since in a general additive category there is the notion of scalar multiplication by \mathbb{N} (see Definition 2.2) but not necessarily an operation corresponding to scalar multiplication by non-negative rationals $\mathbb{Q}_{\geq 0}$. That said, we will later see that in an integral category scalar multiplication by $\mathbb{Q}_{\geq 0}$ is possible with Proposition 3.20 and Proposition 3.24. The integral of monomials identity is re-expressed as:

$$(n+1) \int_0^x t^n dt = x^{n+1}$$

This re-expression of the identity holds in any integral category as we will see in Proposition 3.17. The proof of the polynomial integration formula is actually quite elegant and demonstrates the utility of the graphical calculus. The beauty of the proof of the polynomial integration formula is that it uses every axiom: integration of constants, the Rota-Baxter rule and the Independence rule. In fact, polynomial integration in classical calculus also uses all three axioms but the use of the independence rule goes unnoticed, since in the classical calculus case, the independence rule is simply a change of variables. Furthermore, an important consequences of polynomial integration will be Proposition 3.20 and Propo-

sition 3.24 which state that the natural numbers are in fact invertible in an integral category!

To express the polynomial integration identity in integral categories, we will need the n -fold comultiplication. For every natural number $n \in \mathbb{N}$, define the n -fold comultiplication:

$$\Delta_{n,A} : !A \rightarrow \underbrace{!A \otimes \dots \otimes !A}_{n\text{-times}}$$

by comultiplying $!A$ into n copies of $!A$. Explicitly one can write $\Delta_{n,A}$ as follows:

$$\Delta_n = \Delta(\Delta \otimes 1)(\Delta \otimes 1 \otimes 1) \dots (\Delta \otimes \underbrace{1 \otimes \dots \otimes 1}_{n-2\text{-times}})$$

However by co-associativity, we could have comultiplied in any other order. For example, we could have expressed Δ_4 as follows:

$$\Delta_4 = \Delta(1 \otimes \Delta)(1 \otimes \Delta \otimes 1)$$

Note the following for the cases $n = 0, 1$ and 2 :

- (i) When $n = 0$, $\Delta_{0,A} = e_A$ (since zero copies of $!A$ is the monoidal unit);
- (ii) When $n = 1$, $\Delta_{1,A} = 1_{!A}$;
- (iii) When $n = 2$, $\Delta_{2,A} = \Delta_A$.

We often simply write Δ_n when there is no confusion.

With this n -fold comultiplication, we can now properly express and prove a rule for integration of monomials in integral categories which works properly.

Proposition 3.17. *Let $(\mathbb{X}, \otimes, K, \lambda, \rho, \sigma)$ be an integral category with coalgebra modality $(!, \delta, \varepsilon, \Delta, e)$ and integral combinator S (or equivalently an integral transformation \mathfrak{s}). For every natural number $n \in \mathbb{N}$, the following equalities hold:*

[S. Poly] For every map $f : \underbrace{A \otimes \dots \otimes A}_{n+1\text{-times}} \rightarrow B$, the integral combinator satisfies the following:

$$(n+1) \cdot \mathcal{S}[(\Delta_n \otimes 1)(\underbrace{\varepsilon \otimes \dots \otimes \varepsilon}_{n\text{-times}} \otimes 1)f] = \Delta_{n+1}(\underbrace{\varepsilon \otimes \dots \otimes \varepsilon}_{(n+1)\text{-times}})f$$

Equivalently for the integral transformation:

[s. Poly] The integral transformation satisfies the following:

$$(n+1) \cdot \mathfrak{s}(\Delta_n \otimes 1)(\underbrace{\varepsilon \otimes \dots \otimes \varepsilon}_{n\text{-times}} \otimes 1) = \Delta_{n+1}(\underbrace{\varepsilon \otimes \dots \otimes \varepsilon}_{(n+1)\text{-times}})$$

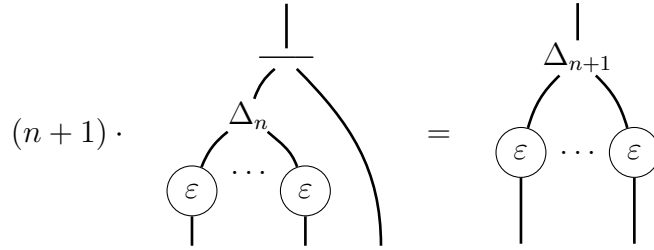

Proof. We will prove **[s. Poly]** by induction on n . For the base case of $n = 0$, this equality holds directly by the constant rule **[s.1]** since $\Delta_{0,A} = e_A$. Assume the induction hypothesis **[s. Poly]** holds for n , we now show it for $n + 1$ (the abbreviation IH below stands for induction hypothesis):

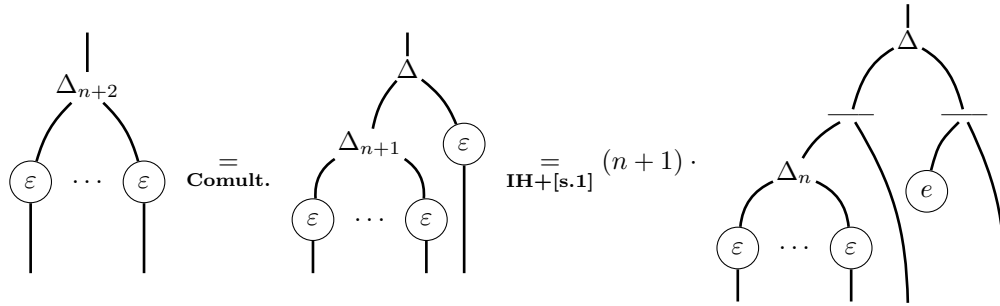

$$\stackrel{=}{[\text{s.2}]} (n+1) \cdot \text{Diagram 1} + (n+1) \cdot \text{Diagram 2}$$

Diagram 1: A tree structure with a root node $\overline{\quad}$. A left child Δ_n has two children ε and ε . A right child Δ has a left child $\overline{\quad}$ and a right child e . The root node has a left child $\overline{\quad}$ and a right child Δ .

Diagram 2: A tree structure with a root node $\overline{\quad}$. A left child Δ_n has two children ε and ε . A right child Δ has a left child $\overline{\quad}$ and a right child e . The root node has a left child $\overline{\quad}$ and a right child Δ .

$$\stackrel{=}{\text{counit}} (n+1) \cdot \text{Diagram 3} + (n+1) \cdot \text{Diagram 4}$$

Diagram 3: A tree structure with a root node $\overline{\quad}$. A left child Δ_n has two children ε and ε . A right child Δ has a left child $\overline{\quad}$ and a right child e . The root node has a left child $\overline{\quad}$ and a right child Δ .

Diagram 4: A tree structure with a root node $\overline{\quad}$. A left child Δ_n has two children ε and ε . A right child Δ has a left child $\overline{\quad}$ and a right child e . The root node has a left child $\overline{\quad}$ and a right child Δ .

$$\stackrel{=}{\mathbf{IH}+[\text{s.1}]} (n+1) \cdot \text{Diagram 5} + (n+1) \cdot \text{Diagram 6}$$

Diagram 5: A tree structure with a root node $\overline{\quad}$. A left child Δ_{n+1} has two children ε and ε . A right child Δ has a left child $\overline{\quad}$ and a right child e . The root node has a left child $\overline{\quad}$ and a right child Δ .

Diagram 6: A tree structure with a root node $\overline{\quad}$. A left child Δ_{n+1} has two children ε and ε . A right child Δ has a left child $\overline{\quad}$ and a right child e . The root node has a left child $\overline{\quad}$ and a right child Δ .

$$\stackrel{=}{\mathbf{IH}} (n+1)^2 \cdot \text{Diagram 7} + (n+1)^2 \cdot \text{Diagram 8}$$

Diagram 7: A tree structure with a root node $\overline{\quad}$. A left child Δ_{n+1} has two children ε and ε . A right child Δ has a left child $\overline{\quad}$ and a right child e . The root node has a left child $\overline{\quad}$ and a right child Δ .

Diagram 8: A tree structure with a root node $\overline{\quad}$. A left child Δ_n has two children ε and ε . A right child Δ has a left child $\overline{\quad}$ and a right child e . The root node has a left child $\overline{\quad}$ and a right child Δ .

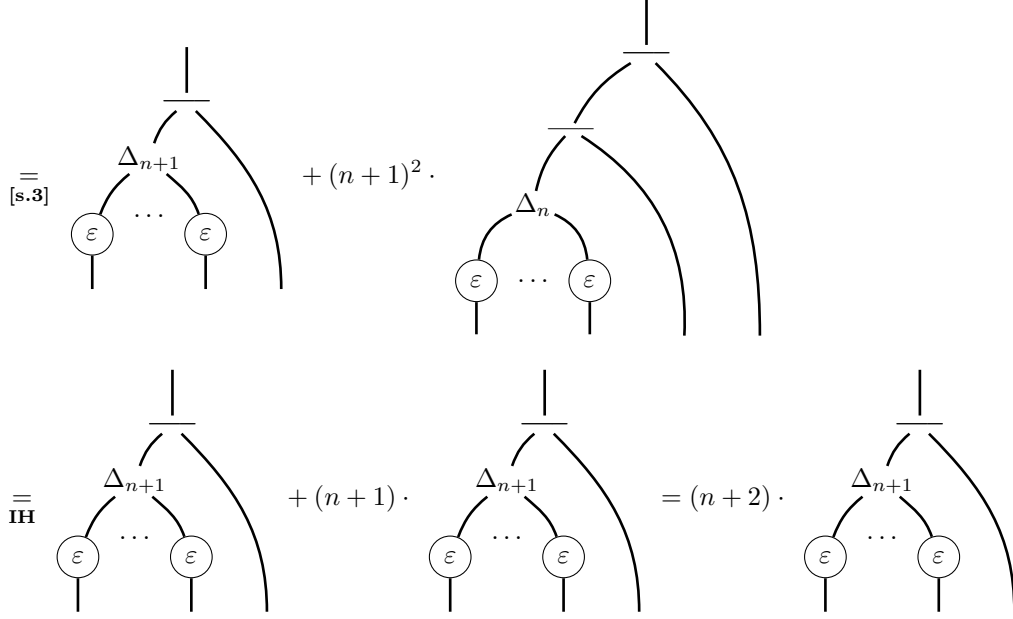

□

In classical calculus notation, the dt always appears at the end of the expression of the integral. However, as we will see in Proposition 3.18, for integral categories the position of the linear part dt is unimportant when integrating polynomials. Intuitively, Proposition 3.18 can be expressed using classical calculus notation as follows:

$$\int_0^x t^n dt = \int_0^x t^k dt t^{n-k}$$

Since there are a total of $n + 1$ places (since k goes from 0 to n) for the monomial t^n where we can place dt , then we also get the following equality:

$$\sum_{k=0}^n \int_0^x t^k dt t^{n-k} = (n + 1) \cdot \int_0^x t^n dt$$

To express these formulas in integral categories, we need to introduce notation for a specific twist map.

In any symmetric monoidal category \mathbb{X} , for each finite family of objects $\{A_1, \dots, A_n\}$ and

for each $k \leq n$, define the following permutation isomorphism:

$$\omega_{(k \ n)} : A_1 \otimes \dots \otimes A_n \rightarrow A_1 \otimes \dots \otimes A_n \otimes \dots \otimes A_k$$

which swaps the last tensor factor and the k -th tensor factor. Notice that $\omega_{(n \ n)}$ is the identity and when $k = 0$, define $\omega_{(0 \ n)}$ as follows:

$$\omega_{(0 \ n)} : A_1 \otimes \dots \otimes A_n \rightarrow A_n \otimes A_1 \otimes \dots \otimes A_{n-1}$$

For each finite family of objects of size $n \geq 1$ there are $n + 1$ of these kinds of permutation isomorphisms.

Proposition 3.18. *Let $(\mathbb{X}, \otimes, K, \lambda, \rho, \sigma)$ be an integral category with coalgebra modality $(!, \delta, \varepsilon, \Delta, e)$ and integral combinator \mathbf{S} (or equivalently an integral transformation \mathbf{s}). For every natural number $n \in \mathbb{N}$ and every $k \leq n$ the following equality holds:*

$$\mathbf{s}(\Delta_n \otimes 1) \underbrace{(\varepsilon \otimes \dots \otimes \varepsilon \otimes 1)}_{n\text{-times}} \omega_{(k \ n)} = \mathbf{s}(\Delta_n \otimes 1) \underbrace{(\varepsilon \otimes \dots \otimes \varepsilon \otimes 1)}_{n\text{-times}}$$

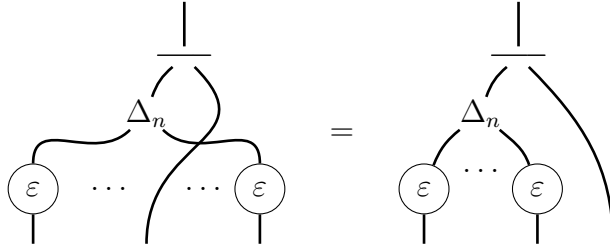

Proof. We prove this by induction on n using both the independence rule [s.3] and polynomial integration rule [s.poly]. Again, the base $n = 0$ is the integral transformation axiom [s.1] since $\Delta_{0,A} = e_A$. Assume the induction hypothesis holds for n , we now show it for $n + 1$

and for any $k \leq n + 1$:

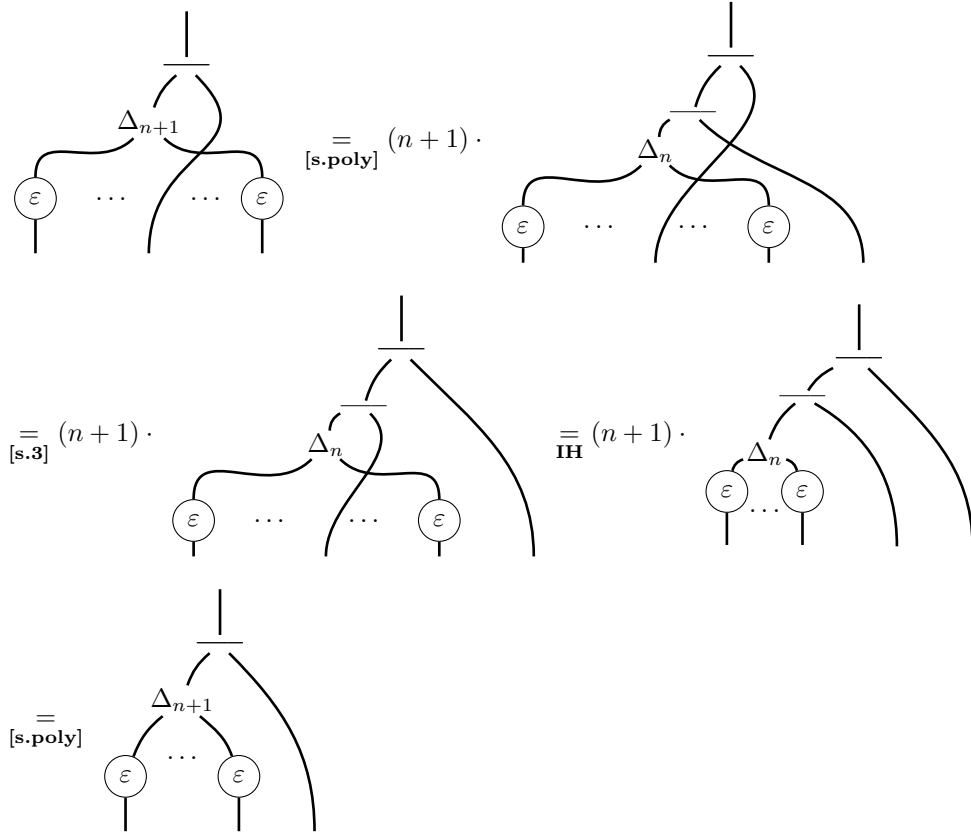

□

We now prove the fact that summing over all possible placement of the linear part dt is equal to multiplying by $n + 1$.

Proposition 3.19. *Let $(\mathbb{X}, \otimes, K, \lambda, \rho, \sigma)$ be an integral category with coalgebra modality $(!, \delta, \varepsilon, \Delta, e)$ and integral combinator \mathbf{S} (or equivalently an integral transformation \mathbf{s}). For every natural number $n \in \mathbb{N}$, the following equality holds:*

$$\sum_{k=1}^n \mathbf{s}(\Delta_n \otimes 1) \underbrace{(\varepsilon \otimes \dots \otimes \varepsilon \otimes 1)}_{n\text{-times}} \omega_{(k\ n)} = \Delta_{n+1} \underbrace{(\varepsilon \otimes \dots \otimes \varepsilon)}_{(n+1)\text{-times}}$$

Proof. For each $n \geq 1$ there is a total of $n + 1$ of permutation isomorphisms of the form

$\omega_{(k\ n)}$. Then we have the following equality:

$$\begin{aligned}
\sum_{k=0}^n \mathbf{s}(\Delta_n \otimes 1) \underbrace{(\varepsilon \otimes \dots \otimes \varepsilon \otimes 1)}_{n\text{-times}} \omega_{(k\ n)} &= \sum_{k=0}^n \mathbf{s}(\Delta_n \otimes 1) \underbrace{(\varepsilon \otimes \dots \otimes \varepsilon \otimes 1)}_{n\text{-times}} && \text{(Prop. 3.18)} \\
&= (n+1) \cdot \mathbf{s}(\Delta_n \otimes 1) \underbrace{(\varepsilon \otimes \dots \otimes \varepsilon \otimes 1)}_{n\text{-times}} \\
&= \Delta_{n+1} \underbrace{(\varepsilon \otimes \dots \otimes \varepsilon)}_{(n+1)\text{-times}}
\end{aligned}$$

□

We now turn our attention to the main consequence of polynomial integration: non-negative rationals in an integral category. Recall that in any additive category, for every object A and natural number $n \in \mathbb{N}$, one can define the map $n_A : A \rightarrow A$ as follows:

$$n_A = n \cdot 1_A$$

We will now prove that in any integral category that for every object A and $n \geq 2$, the map $n_{!A}$ is invertible.

Proposition 3.20. *Let $(\mathbb{X}, \otimes, K, \lambda, \rho, \sigma)$ be an integral category with coalgebra modality $(!, \delta, \varepsilon, \Delta, e)$ and integral transformation \mathbf{s} . For every natural number $n \in \mathbb{N}$, $n \geq 2$, and every object $A \in \mathbb{X}$, the map $n_{!A} : !A \rightarrow !A$ is an isomorphism.*

Remark 3.21. Notice that the case $n = 1$ is also true since the identity map is an isomorphism.

Proof. For every $n \geq 2$ and every object $A \in \mathbb{X}$, define $n_{!A}^{-1} : !A \rightarrow !A$ as follows:

$$n_{!A}^{-1} = \delta_A \mathbf{s}_{!A} (\Delta_{n-1, !A} \otimes 1_{!A}) \underbrace{(\varepsilon_{!A} \otimes \dots \otimes \varepsilon_{!A} \otimes 1_{!A})}_{n-1\text{-times}} (1_{!A} \otimes \underbrace{e_A \otimes \dots \otimes e_A}_{n-1\text{-times}})$$

In string diagrams, $n_{!A}^{-1}$ is written out as follows:

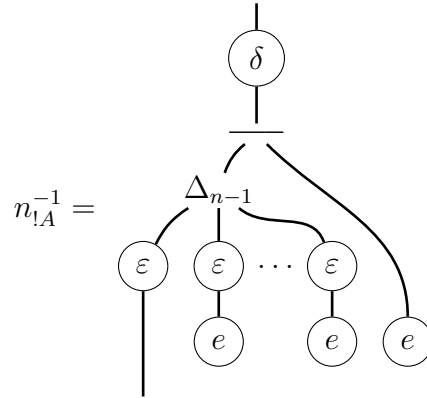

Recall that by definition, we have the following equality:

$$n_{!A}^{-1}n_{!A} = n \cdot n_{!A}^{-1} = n_{!A}n_{!A}^{-1}$$

So it suffices to show that $n \cdot n_{!A}^{-1} = 1_{!A}$. To prove this we use the additive structure, **[s.Poly]**, the comonad triangle identities, that δ is a comonoid morphism and the counit laws for the comultiplication.

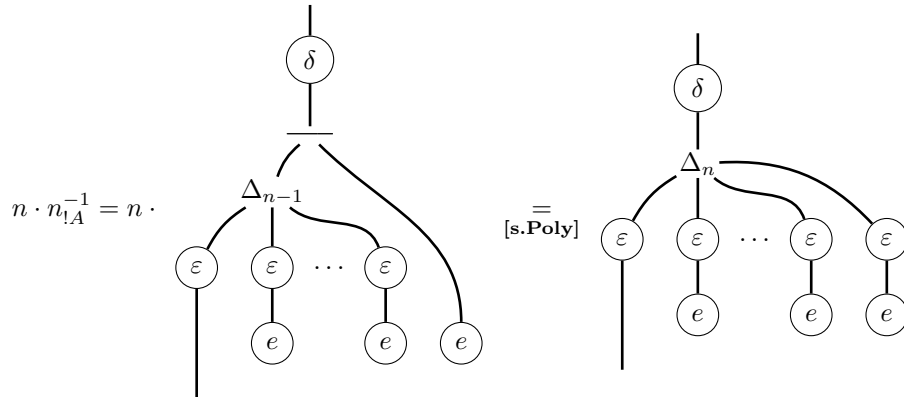

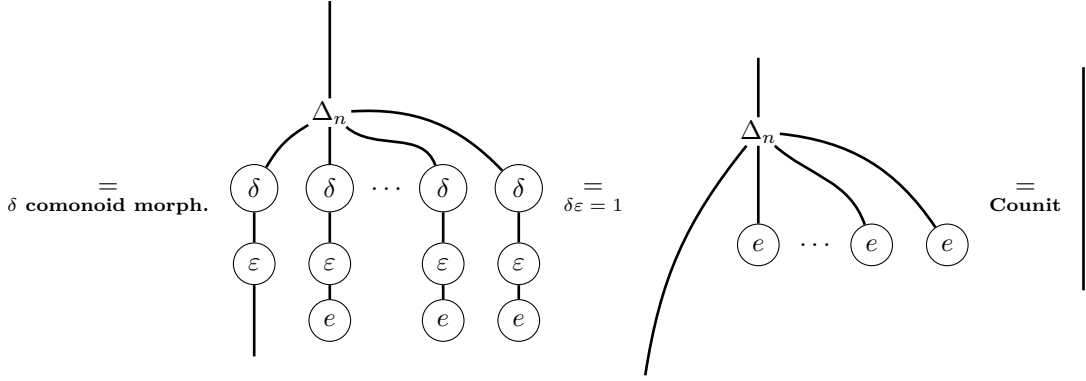

□

In certain integral categories, it is possible to obtain that for every object A and $n \geq 2$, n_A is an isomorphism. For this we require that ε be a natural retraction, that is, there exists a natural transformation η with components $\eta_A : A \rightarrow !A$ such that for each object $A \in \mathbb{X}$, ε_A is a retraction of η_A , i.e, $\eta_A \varepsilon_A = 1_A$. We call η a natural section of ε . It is not uncommon for ε to be a natural retraction, in fact it is closely related to differential category structure [8, 15, 18] and both our main examples of comonads have this property.

Example 3.22. The natural transformation ε for finite bag comonad $(!, \delta, \varepsilon)$ on REL , given in Example 2.8, is a natural retraction. Explicitly, define $\eta_X : X \rightarrow !X$ as the relation which relates elements of X to their corresponding singleton set:

$$\eta_X = \{(x, \llbracket x \rrbracket) \mid x \in X\} \subset X \times !(X)$$

Example 3.23. The natural transformation η for the free symmetric algebra monad (Sym, η, μ) on $\text{VEC}_{\mathbb{K}}$, given in Example 2.9, is a natural section. Explicitly, define $\varepsilon_V : \text{Sym}(V) \rightarrow V$ on pure tensors maps as follows:

$$\varepsilon_V(w) = \begin{cases} w & \text{if } w \in \text{Sym}^1(V) = V \\ 0 & \text{o.w.} \end{cases}$$

which we then extend by linearity.

We now prove that when ε is a natural retraction, n_A is an isomorphism for every object A and $n \geq 2$.

Proposition 3.24. *Let $(\mathbb{X}, \otimes, K, \lambda, \rho, \sigma)$ be an integral category with coalgebra modality $(!, \delta, \varepsilon, \Delta, e)$ and integral transformation \mathfrak{s} such that ε is a natural retraction. For every natural number $n \in \mathbb{N}$, $n \geq 2$, and every object $A \in \mathbb{X}$, the map $n_A : A \rightarrow A$ is an isomorphism.*

Proof. Let η be a natural section of ε . For every $n \geq 2$ and every object $A \in \mathbb{X}$, define $n_A^{-1} : !A \rightarrow !A$ as follows:

$$n_A^{-1} = \eta_A n_{!A}^{-1} \varepsilon_A$$

where $n_{!A}^{-1}$ is defined as in the proof of Proposition 3.20. In string diagrams, $n_{!A}^{-1}$ is written out as follows:

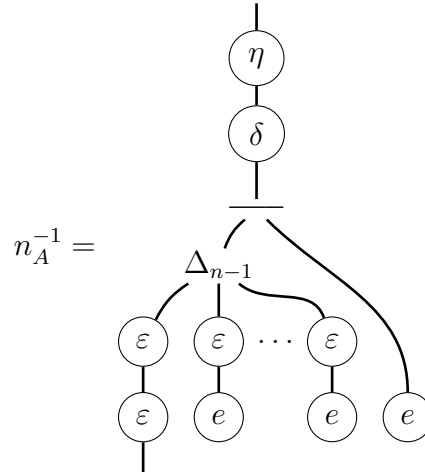

Recall that by definition, we have the following equality:

$$n_A^{-1} n_A = n \cdot n_A^{-1} = n_A n_A^{-1}$$

So it suffices to show that $n \cdot n_A^{-1} = 1_{!A}$. Here we use the additive structure, that $n \cdot n_{!A}^{-1} = 1_{!A}$

(by Proposition 3.20) and that $\eta_A \varepsilon_A = 1_A$.

$$n \cdot n_A^{-1} = n \cdot (\eta_A n_{!A}^{-1} \varepsilon_A) = \eta_A (n \cdot n_{!A}^{-1}) \varepsilon_A = \eta_A 1_{!A} \varepsilon_A = \eta_A \varepsilon_A = 1_A$$

□

Proposition 3.24 implies that an integral category where ε is a natural retraction, is enriched over $\mathbb{Q}_{\geq 0}$ -modules, that is, every hom-set is a $\mathbb{Q}_{\geq 0}$ -module. The scalar multiplication of a map $f : A \rightarrow B$ with a non-negative rational $\frac{p}{q} \in \mathbb{Q}_{\geq 0}$ is the map $\frac{p}{q} \cdot f : A \rightarrow B$ defined as follows:

$$\frac{p}{q} \cdot f = p \cdot (q_A^{-1} f)$$

3.6 Other Integral Properties

We finish this chapter by examining other properties in integral categories. The first property simply states that the integral evaluated at zero is zero.

Proposition 3.25. *Let $(\mathbb{X}, \otimes, K, \lambda, \rho, \sigma)$ be an integral category with coalgebra modality $(!, \delta, \varepsilon, \Delta, e)$ and integral combinator \mathbf{S} (or equivalently an integral transformation \mathbf{s}). Then for each integrable map $f : !A \otimes A \rightarrow B$, the following equality holds:*

$$!(0_{A,A})\mathbf{S}[f] = 0_{!A,B}$$

Proof. This is straightforward by naturality:

$$!(0)\mathbf{S}[f] = !(0)\mathbf{s}_A f = \mathbf{s}_A(! (0) \otimes 0) f = 0$$

□

The next property gives sufficient conditions for when two maps have the same integral.

Proposition 3.26. *Let $(\mathbb{X}, \otimes, K, \lambda, \rho, \sigma)$ be an integral category with coalgebra modality $(!, \delta, \varepsilon, \Delta, e)$ and integral combinator \mathbf{S} (or equivalently an integral transformation \mathbf{s}). If for any pair of integrable maps $f, g : !A \otimes A \rightarrow B$ the following equality holds:*

$$(1_{!A} \otimes \varepsilon_A)f = (1_{!A} \otimes \varepsilon_A)g$$

then $\mathbf{S}[f] = \mathbf{S}[g]$.

Proof. Suppose that $(1_{!A} \otimes \varepsilon_A)f = (1_{!A} \otimes \varepsilon_A)g$. Then notice the following equality:

$$\begin{aligned} !(\varepsilon_A)\mathbf{S}[f] &= !(\varepsilon_A)\mathbf{s}_A f \\ &= \mathbf{s}_{!A}(!(\varepsilon_A) \otimes \varepsilon_A)f && \text{(Naturality of } \mathbf{s} \text{)} \\ &= \mathbf{s}_{!A}(!(\varepsilon_A) \otimes 1_A)(1_{!A} \otimes \varepsilon_A)f \\ &= \mathbf{s}_{!A}(!(\varepsilon_A) \otimes 1_A)(1_{!A} \otimes \varepsilon_A)g \\ &= \mathbf{s}_{!A}(!(\varepsilon_A) \otimes \varepsilon_A)g \\ &= !(\varepsilon_A)\mathbf{s}_A f \\ &= !(\varepsilon_A)\mathbf{S}[g] \end{aligned}$$

Therefore since $(!, \delta, \varepsilon)$ is a comonad and $!(\varepsilon_A)\mathbf{S}[f] = !(\varepsilon_A)\mathbf{S}[g]$, we have that:

$$\mathbf{S}[f] = \delta_A !(\varepsilon_A)\mathbf{S}[f] = \delta_A !(\varepsilon_A)\mathbf{S}[g] = \mathbf{S}[g]$$

□

The last property we will provide is a property which derives from the theory of Rota-Baxter algebras. In the theory of Rota-Baxter algebras, the Rota-Baxter operator induces a new commutative semigroup structure on the algebra [21]. A similar result can be expressed in an integral category, giving a cocommutative co-semigroup structure for $!A \otimes A$ (where a co-semigroup is the dual notion of a semigroup).

Proposition 3.27. *Let $(\mathbb{X}, \otimes, K, \lambda, \rho, \sigma)$ be an integral category with coalgebra modality $(!, \delta, \varepsilon, \Delta, e)$ and integral transformation \mathfrak{s} .*

- (i) *For each object A , $!A \otimes A$ has a natural cocommutative co-semigroup structure where the co-semigroup operation:*

$$\diamond_A : !A \otimes A \rightarrow !A \otimes A \otimes !A \otimes A$$

is defined as follows:

$$\diamond_A = (\Delta_A \otimes 1)(\mathfrak{s}_A \otimes 1 \otimes 1) + (\Delta_A \otimes 1)(1 \otimes \sigma)(1 \otimes 1 \otimes \mathfrak{s}_A)$$

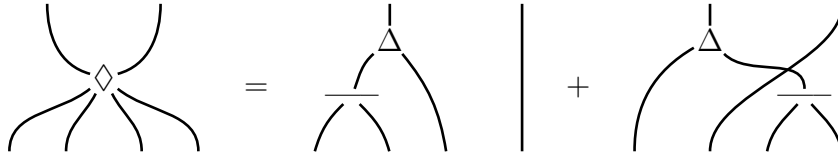

- (ii) *For each object A , the integral transformation $\mathfrak{s}_A : !A \rightarrow !A \otimes A$ is a co-semigroup morphism, that is, the following equality holds:*

$$\mathfrak{s}_A \diamond_A = \Delta_A(\mathfrak{s}_A \otimes \mathfrak{s}_A)$$

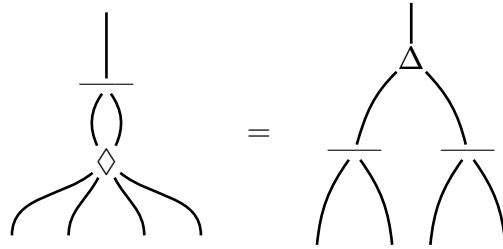

Proof. We will first prove *ii*).

- (*ii*) Notice that this is simply a reiteration of the Rota-Baxter axiom [s.2]:

$$\mathfrak{s}_A \diamond_A = \mathfrak{s}_A((\Delta_A \otimes 1)(\mathfrak{s}_A \otimes 1 \otimes 1) + (\Delta_A \otimes 1)(1 \otimes \sigma)(1 \otimes 1 \otimes \mathfrak{s}_A)) = \Delta_A(\mathfrak{s}_A \otimes \mathfrak{s}_A)$$

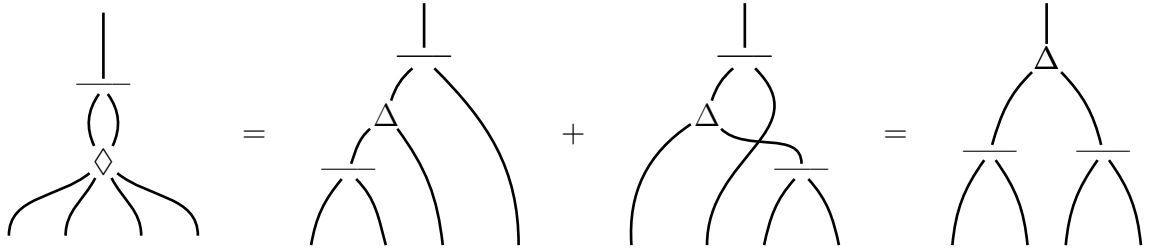

(i) We first show coassociativity of \diamond .

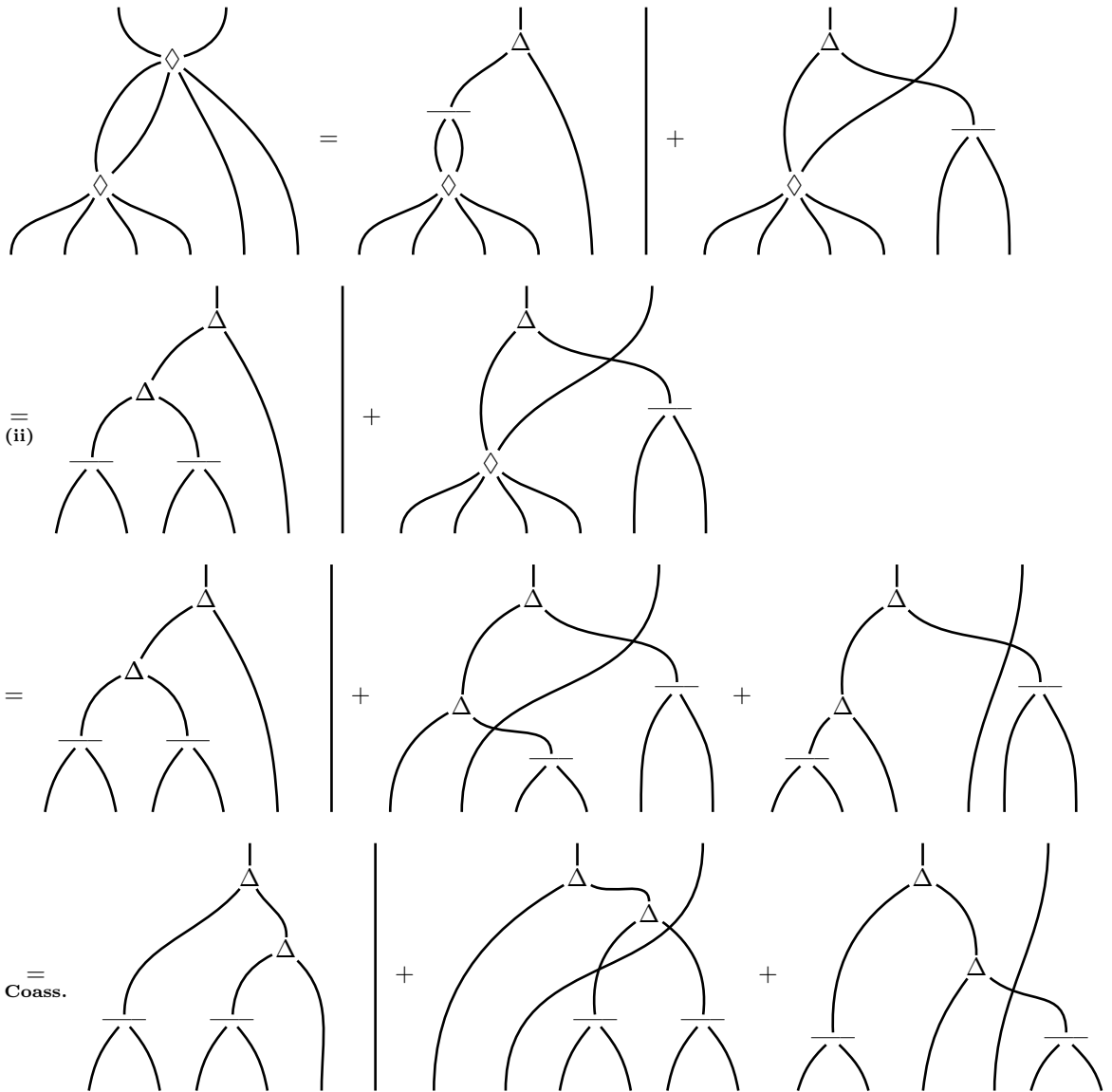

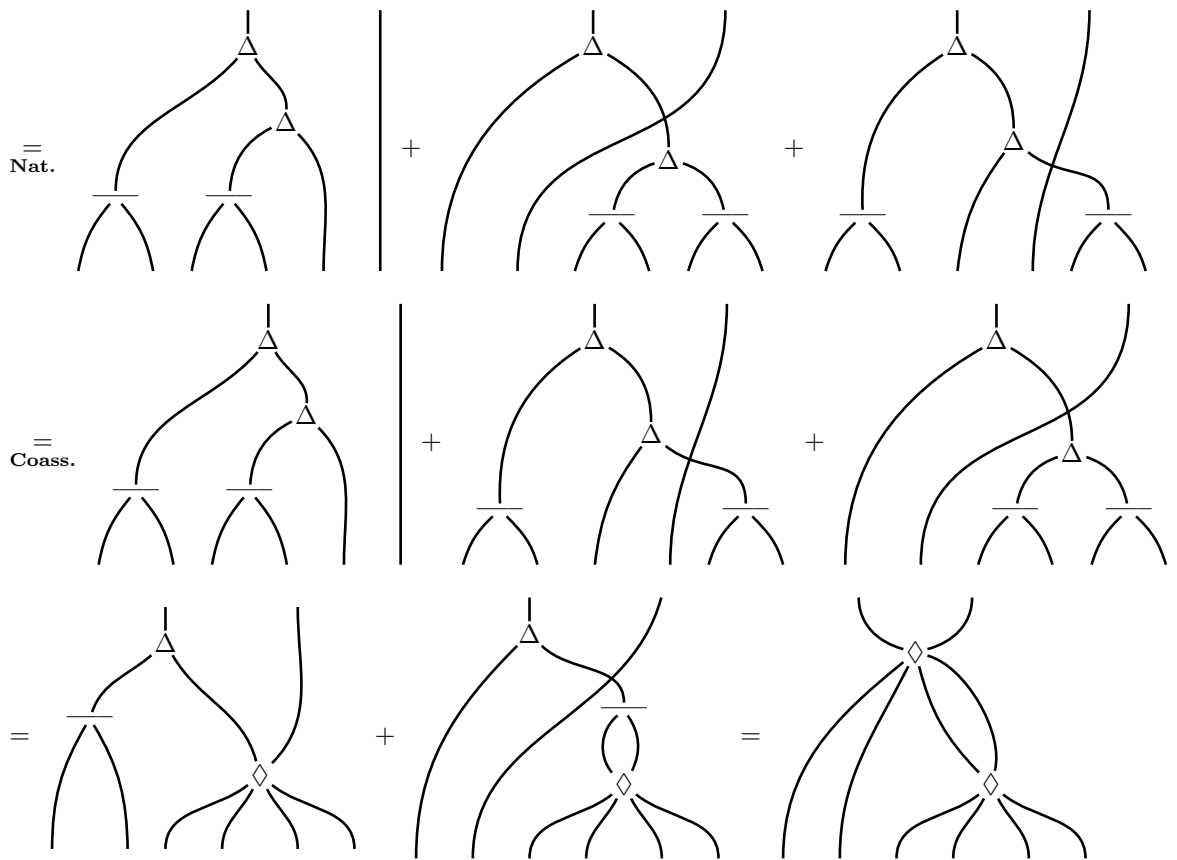

Next we show cocommutativity of \diamond :

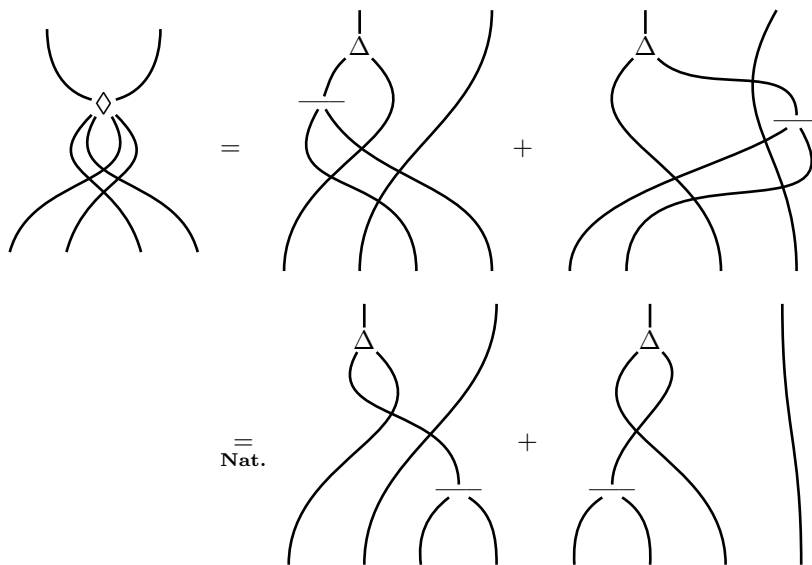

$$\stackrel{\text{Cocom.}}{=} \begin{array}{c} | \\ \triangle \\ \text{---} \\ \text{---} \end{array} \quad \Bigg| \quad + \quad \begin{array}{c} | \\ \triangle \\ \text{---} \\ \text{---} \end{array} = \begin{array}{c} \text{---} \\ \text{---} \\ \diamond \\ \text{---} \\ \text{---} \end{array}$$

□

3.7 Fubini's theorem

In this last section, we discuss briefly the interpretation of Fubini's theorem in integral categories. Briefly, Fubini's theorem states that for a function f in two variables, say x and y , the following equality holds:

$$\int_Y \left(\int_X f(x, y) \, dx \right) dy = \int_X \left(\int_Y f(x, y) \, dy \right) dx$$

that is, where X and Y are the domains of definition of x and y respectively, integrating f with respect to x first then y is the same as integrating f with respect to y then x . Under our intuition for integration for integral categories, this implies we are dealing with a function in four variables x, y, dx and dy which is bilinear in dx and dy .

The reader may notice the similarities with the axiom **[S.3]**, the independence rule, for integral categories. However there are crucial differences. First, Fubini's theorem concerns to the double integral of integrating a function in two different variables while the axiom **[S.3]** explains the process of integrating the same variable twice. Secondly, the double integral in Fubini's theorem is an iterated integral, where the function is integrated as a function of a single variable by holding the other variable constant. On the other hand, **[S.3]** takes all variables into consideration at once. This notion of making other variables constant does not coincide with the integral transformation in Example 3.15 for the category of vector spaces. Indeed, consider the simple integrable function $f(x, y, dx, dy) = xy dx dy$. The double integral

of f under Fubini's theorem produces the following function:

$$\int_Y \left(\int_X f(x, y) \, dx \right) \, dy = \int_Y \left(\int_X xy \, dx \right) \, dy = \int_Y \frac{1}{2} x^2 y \, dy = \frac{1}{4} x^2 y^2$$

while the double integral of f under **[S.3]** produces:

$$\mathbb{S}[\mathbb{S}[f(x, y) \, dx] \, dy] = \mathbb{S}[\mathbb{S}[xy \, dx] \, dy] = \mathbb{S}\left[\frac{1}{3} x^2 y \, dy\right] = \frac{1}{12} x^2 y^2$$

This discrepancy is due to the fact the integral transformation takes the sum of the polynomial degrees of each variable plus one when integrating, while the iterated integral only takes the degree plus one of the variable which is being integrated. Therefore, we will need a different approach in the interpretation of Fubini's theorem.

To interpret Fubini's theorem in an integral category we will require that our category have finite biproducts [29] and that our coalgebra modality has Seely isomorphisms [5, 8, 9]. We will not go into detail about the required theory, but we will quickly define the Seely isomorphism. A coalgebra modality has a Seely isomorphism if there exists a natural isomorphism χ with components $\chi_{A,B} : !A \otimes !B \rightarrow !(A \times B)$, natural in A and B , which is inverse to the natural isomorphism χ^{-1} with components $\Delta_{A \times B}(!(\pi_0) \otimes !(\pi_1)) : !(A \times B) \rightarrow !A \otimes !B$ where π_0 and π_1 are the projection maps. The Seely isomorphisms will allow us to separate our variables and keep them constant when they are not being integrated. Therefore, in the presence of biproducts and the Seely isomorphisms, the iterated integral of a map $f : !(A \times B) \otimes A \otimes B \rightarrow C$ is obtained as follows:

$$\begin{array}{ccccccc} ! (A \times B) & \xrightarrow{\chi_{A,B}^{-1}} & !A \otimes !B & \xrightarrow{\mathfrak{s}_A \otimes \mathfrak{s}_B} & !A \otimes !A \otimes !B \otimes B & \xrightarrow{1 \otimes \sigma \otimes 1} & \\ & & & & & & \\ !A \otimes !B \otimes A \otimes B & \xrightarrow{\chi_{A,B} \otimes 1 \otimes 1} & !(A \times B) \otimes A \otimes B & \xrightarrow{f} & C & & \end{array}$$

By the bifactoriality of the tensor product, Fubini's theorem becomes trivial in this context.

Chapter 4

Differential Categories

In this chapter we give a quick introduction to differential categories [8] by giving the definition and examples. We summarize the definitions given in [8]. We will not explore the extra properties of differential categories (some which can be found in [7]). The structure of this chapter mirrors precisely that of Chapter 3. This should come as no surprise since we expect that integration and differentiation be in some sense dual concepts. In fact, integral categories were inspired and built by mirroring differential categories. In particular, a differential category can be equivalently defined by a combinator, called a differential combinator, or by a natural transformation, called the deriving transformation. We begin by giving the definition of an differential combinator and then we define a deriving transformation. Afterwards we prove that a deriving transformation is indeed equivalent to a differential combinator. We finish this chapter by giving the two main examples of differential categories: the category of vector spaces and the category of sets and relations. Throughout this chapter, we will often refer the reader to the original paper on differential categories [8] for more details.

4.1 Differential Combinator

Here we introduce the notion of a differential category by defining a differential combinator, parallel to our introduction of integral categories with the integral combinator. Briefly, a

differential category is an additive symmetric monoidal category with a coalgebra modality and a differential combinator. Just as with the integral combinator, the differential combinator can be thought of as an operator on certain maps, which are called differentiable, where the resulting map is the derivative of the input map. After giving the definition below, we will give some intuition for the combinator and the axioms that it must satisfy. Now we introduce the definition of a differential combinator.

Definition 4.1. Let $(\mathbb{X}, \otimes, K, \lambda, \rho, \sigma)$ be an additive symmetric monoidal category with a coalgebra modality $(!, \delta, \varepsilon, \Delta, e)$. A **differential combinator** [8] D on $(!, \delta, \varepsilon, \Delta, e)$ is a combinator of the functors $!$, $1_{\mathbb{X}}$, $!(-) \otimes -$ and $1_{\mathbb{X}}$:

$$\frac{f : !A \rightarrow B}{D[f] : !A \otimes A \rightarrow B} D$$

such that D satisfies the following properties:

[D.A] Additivity: For any pair of parallel maps $f, g : !A \rightrightarrows B$, the following equality holds:

$$D[f + g] = D[f] + D[g]$$

[D.N] Naturality/Linear Substitution: If the square on the left commutes, then the square on the right commutes:

$$\begin{array}{ccc} !A & \xrightarrow{f} & B \\ \downarrow !(h) & & \downarrow k \\ !C & \xrightarrow{g} & D \end{array} \Rightarrow \begin{array}{ccc} !A \otimes A & \xrightarrow{D[f]} & B \\ \downarrow !(h) \otimes h & & \downarrow k \\ !C \otimes C & \xrightarrow{D[g]} & D \end{array}$$

[D.1] Derivative of Constants: For every object A , the following equality holds:

$$D[e_A] = 0_{!A \otimes A, K}$$

[D.2] Leibniz Rule/Product Rule: For any pair of maps $f : !A \rightarrow B$ and $g : !A \rightarrow C$, the following equality holds:

$$\mathbf{D}[\Delta_A(f \otimes g)] = (\Delta_A \otimes 1_A)(1_{!A} \otimes \sigma_{!A,A})(\mathbf{D}[f] \otimes g) + (\Delta_A \otimes 1_A)(f \otimes \mathbf{D}[g])$$

[D.3] Derivative of Linear Maps: For every map $f : A \rightarrow B$, the following equality holds:

$$\mathbf{D}[\varepsilon_A f] = (e_A \otimes 1_A)\lambda_A f$$

[D.4] Chain Rule: For every pair of maps $f : !A \rightarrow B$ and $g : !B \rightarrow C$, the following equality holds:

$$\mathbf{D}[\delta_A!(f)g] = (\Delta_A \otimes 1_A)(\delta_A \otimes 1_{!A} \otimes 1_A)(!(f) \otimes \mathbf{D}[f])\mathbf{D}[g]$$

[D.5] Independence Rule: For every pair of maps $f : !B \rightarrow C$ and $g : A \rightarrow B$.

$$(1_{!A} \otimes \sigma_{A,A})(\mathbf{D}![g]) \otimes g \mathbf{D}[f] = (\mathbf{D}![g]) \otimes g \mathbf{D}[f]$$

This leads us to the expected definition of a differential category.

Definition 4.2. A **differential category** [8] is an additive symmetric monoidal category with a coalgebra modality and a differential combinator \mathbf{D} . A map is **differentiable** if it is of the form $f : !A \rightarrow B$ and the **differential** of f is the map $\mathbf{D}[f] : !A \otimes A \rightarrow B$.

As in the integral category chapter, it might be useful for the reader to have some intuition regarding the axioms of a differential combinator. We will not go into as much detail as we did for the integral combinator. For more details on the intuition, we refer the reader to the original paper [8]. The first axiom, [D.A], states that the derivative of a sum of functions is the sum of their derivative. The second axiom, [D.N], is the linear substitution rule for

differentiation (more on this axiom in the following subsection). The next axiom, **[D.1]**, states that the derivative of a constant map is zero. The fourth axiom **[D.2]** is the Leibniz rule for differentiation – also called the product rule. The fifth axiom **[D.3]** says that the derivative of a linear map is a constant. The axiom **[D.4]** is the chain rule. And the last axiom **[D.5]** is the independence of differentiation or the interchange law, which naively states that differentiating with respect to x then y is the same as differentiation with respect to y then x . It should be noted that **[D.5]** was not a requirement in [8] but was later added to the definition [9, 10] to ensure that the coKleisli category of a differential category was a Cartesian differential category.

4.2 Naturality of the Differential Combinator

In this section, we explore the naturality axiom of our combinator **[D.N]** a bit more. The naturality **[D.N]** of the combinator D can be described in an alternative way by splitting it into two:

[D.N.a] Left Linear Substitution: For every pair of maps $h : A \rightarrow C$ and $g : !C \rightarrow B$, the following equality holds:

$$D[!(h)g] = (!(h) \otimes h)D[g]$$

[D.N.b] Right Linear substitution: For every pair of maps $f : !A \rightarrow B$ and $k : B \rightarrow D$, the following equality holds:

$$D[fk] = D[f]k$$

In the following proposition, we prove that these smaller axioms are indeed equivalent to the naturality axiom.

Proposition 4.3. *The following are equivalent:*

(i) **[D.N]**;

(ii) **[D.N.a]** and **[D.N.b]**.

Proof. $i) \Rightarrow ii)$: For **[D.N.a]**, notice that the following square on the left commutes trivially and then by **[D.N]**, the square on the right commutes:

$$\begin{array}{ccc} !A & \xrightarrow{!(h)g} & B \\ !(h)\downarrow & & \parallel 1_D \\ !C & \xrightarrow{g} & D \end{array} \Rightarrow \begin{array}{ccc} !A \otimes A & \xrightarrow{D[!(h)g]} & B \\ !(h)\otimes h \downarrow & & \parallel 1_D \\ !C \otimes C & \xrightarrow{D[g]} & D \end{array}$$

Similarly for **[D.N.b]**, notice that the following square on the left commutes trivially and then by **[D.N]**, the square on the right commutes:

$$\begin{array}{ccc} !A & \xrightarrow{f} & B \\ !(1_A)\parallel & & \downarrow k \\ !C & \xrightarrow{fk} & D \end{array} \Rightarrow \begin{array}{ccc} !A \otimes A & \xrightarrow{D[f]} & B \\ !(1_A)\otimes 1_A \parallel & & \downarrow k \\ !C \otimes A & \xrightarrow{D[fk]} & D \end{array}$$

$ii) \Rightarrow i)$: Suppose that $fk = !(h)g$ for the appropriate maps f, g, h and k . Then by **[D.N.a]** and **[D.N.b]**, we have the following equality:

$$(!(h) \otimes h)D[g] = D[!(h)g] = D[fk] = D[f]k$$

□

These two axioms of naturality, **[D.N.a]** and **[D.N.b]**, were not included in [8]. We have added them here for completeness.

Naturality of the differential combinator also gives a general way of describing the differential of maps. Notice by naturality of the differential combinator, since the square on the

left commutes trivially for every differentiable map, the square on the right commutes:

$$\begin{array}{ccc}
 !A & \xrightarrow{1_{!A}} & !A \\
 \parallel^{!(1_A)} & & \downarrow f \\
 !A & \xrightarrow{f} & B
 \end{array}
 \Rightarrow
 \begin{array}{ccc}
 !A \otimes A & \xrightarrow{D[1_{!A}]} & !A \\
 \parallel^{!(1_A) \otimes 1_A} & & \downarrow f \\
 !A \otimes A & \xrightarrow{D[f]} & B
 \end{array}$$

Therefore, we get the following proposition:

Proposition 4.4. *Let $(\mathbb{X}, \otimes, K, \lambda, \rho, \sigma)$ be differential category with coalgebra modality $(!, \delta, \varepsilon, \Delta, e)$ and differential combinator D . Then for every differentiable map $f : !A \rightarrow B$:*

$$D[f] = D[1_{!A}]f$$

If we define $d_A = D[1_{!A}] : !A \otimes A \rightarrow !A$, then by the above proposition:

$$D[f] = d_A f$$

for every differentiable map $f : !A \rightarrow B$. In fact, the differential combinator D can be completely re-expressed in terms of d , which we discuss in the next section.

4.3 Deriving Transformation

In this section we introduce the deriving transformation. The deriving transformation will allow us to differentiate maps by precomposition. We also introduce the graphical calculus for the deriving transformation and draw out the axioms of the deriving transformation as string diagrams.

Definition 4.5. Let $(\mathbb{X}, \otimes, K, \lambda, \rho, \sigma)$ be an additive symmetric monoidal category with a coalgebra modality $(!, \delta, \varepsilon, \Delta, e)$. A **deriving transformation** [8, 7, 11] is a natural

transformation d with components $d_A : !A \otimes A \rightarrow !A$

$$d = \begin{array}{c} \text{---} \\ \text{---} \\ \text{---} \\ | \end{array}$$

such that for each object $A \in \text{Ob}(\mathbb{X})$, d_A satisfies the following properties:

[d.1] Derivative of constants:

$$d_A e_A = 0_{!A \otimes A, K}$$

$$\begin{array}{c} \text{---} \\ \text{---} \\ \text{---} \\ | \\ \text{---} \\ \text{---} \\ \text{---} \\ | \end{array} = 0$$

[d.2] Leibniz Rule/Product Rule:

$$d_A \Delta_A = (\Delta_A \otimes 1_A)(1_{!A} \otimes \sigma_{A, !A})(d_A \otimes 1_{!A}) + (\Delta_A \otimes 1_A)(1_{!A} \otimes d_A)$$

$$\begin{array}{c} \text{---} \\ \text{---} \\ \text{---} \\ | \\ \text{---} \\ \text{---} \\ \text{---} \\ | \end{array} = \begin{array}{c} \text{---} \\ \text{---} \\ \text{---} \\ | \\ \text{---} \\ \text{---} \\ \text{---} \\ | \end{array} + \begin{array}{c} \text{---} \\ \text{---} \\ \text{---} \\ | \\ \text{---} \\ \text{---} \\ \text{---} \\ | \end{array}$$

[d.3] Derivative of Linear Maps:

$$d_A \varepsilon_A = (e_A \otimes 1_A) \lambda_A$$

$$\begin{array}{c} \text{---} \\ \text{---} \\ \text{---} \\ | \\ \text{---} \\ \text{---} \\ \text{---} \\ | \end{array} = \begin{array}{c} \text{---} \\ \text{---} \\ \text{---} \\ | \\ \text{---} \\ \text{---} \\ \text{---} \\ | \end{array} \quad \begin{array}{c} \text{---} \\ \text{---} \\ \text{---} \\ | \end{array}$$

[d.4] Chain Rule:

$$\mathbf{d}_A \delta_A = (\Delta_A \otimes 1_A)(\delta_A \otimes 1_{!A} \otimes 1_A)(1_{!(!A)} \otimes \mathbf{d}_A)\mathbf{d}_{!A}$$

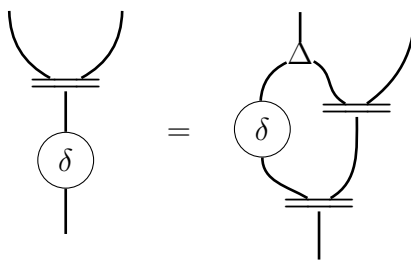

[d.5] Independence Rule:

$$(\mathbf{d}_A \otimes 1_A)\mathbf{d}_A = (1_{!A} \otimes \sigma_{A,A})(\mathbf{d}_A \otimes 1_A)\mathbf{d}_A$$

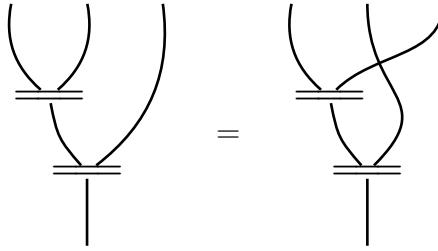

The axioms for the deriving transformation are simple re-expressions of the axioms for the differential combinator.

We now prove that a differential combinator is equivalent to a deriving transformation. The equivalence was proven in [8], however we have chosen to reproduce the proof here in more detail for completeness.

The equational proofs in the following proposition are short and straightforward. Therefore, we will not use the graphical calculus here.

Proposition 4.6. [8] *Let $(\mathbb{X}, \otimes, K, \lambda, \rho, \sigma)$ be a differential category with a coalgebra modality $(!, \delta, \varepsilon, \Delta, e)$ and differential combinator \mathbf{D} . Then \mathbf{D} induces a deriving transformation \mathbf{d} whose components $\mathbf{d}_A : !A \otimes A \rightarrow !A$ are defined as $\mathbf{d}_A = \mathbf{D}[1_{!A}]$.*

Proof. Throughout this proof, we will make repeatedly use **[D.N]**. We first show naturality of \mathbf{d} . Notice that for every map $f : A \rightarrow B$, the square on the left commutes trivially and so by **[D.N]**, the square on the right commutes:

$$\begin{array}{ccc} !A \xrightarrow{1_{!A}} !A & & !A \otimes A \xrightarrow{D[1_{!A}]} !A \\ \downarrow !(f) & \Rightarrow & \downarrow !(f) \otimes f \\ !B \xrightarrow{1_{!B}} !B & & !B \otimes B \xrightarrow{D[1_{!B}]} !B \end{array}$$

The square on the right is precisely the naturality condition of \mathbf{d} .

Recall that we have also already shown that by **[D.N]**, for every differentiable map $f : !A \rightarrow B$, $D[f] = D[1_{!A}]f$. With this identity, we can prove **[d.1]** to **[d.5]**.

[d.1] For the derivative of constants rule, we obtain the following equality by **[D.1]**:

$$\mathbf{d}_A e_A = D[1_{!A}]e_A = D[e_A] = 0$$

[d.2] For the Leibniz Rule, we obtain the following equality by **[D.2]**:

$$\begin{aligned} \mathbf{d}_A \Delta_A &= D[1_{!A}] \Delta_A \\ &= D[\Delta_A] \\ &= (\Delta_A \otimes 1_A)(1_{!A} \otimes \sigma_{A,!A})(D[1_{!A}] \otimes 1_{!A}) + (\Delta_A \otimes 1_A)(1_{!A} \otimes D[1_{!A}]) \\ &= (\Delta_A \otimes 1_A)(1_{!A} \otimes \sigma_{A,!A})(\mathbf{d}_A \otimes 1_{!A}) + (\Delta_A \otimes 1_A)(1_{!A} \otimes \mathbf{d}_A) \end{aligned}$$

[d.3] For the derivative of linear maps rule, we obtain the following equality by **[D.3]**:

$$\mathbf{d}_A \varepsilon_A = D[1_{!A}]\varepsilon_A = D[\varepsilon_A] = (e_A \otimes 1_A)\lambda_A$$

[d.4] For the derivative chain rule, we obtain the following equality by [D.4]:

$$\begin{aligned}
d_A \delta_A &= D[1_{!A}] \delta_A \\
&= D[\delta_A] \\
&= (\Delta_A \otimes 1_A)(\delta_A \otimes 1_{!A} \otimes 1_A)(!(1_{!A}) \otimes D[1_{!A}])D[1_{!(1_A)}] \\
&= (\Delta_A \otimes 1_A)(\delta_A \otimes 1_{!A} \otimes 1_A)(1_{!(1_A)} \otimes d_A)d_{!A}
\end{aligned}$$

[d.5] For the independence rule, we obtain the following equality by [D.5]:

$$\begin{aligned}
(d_A \otimes 1_A)d_A &= (1_{!A} \otimes \sigma_{A,A})(D[1_{!A}] \otimes 1_A)D[1_{!A}] \\
&= (1_{!A} \otimes \sigma_{A,A})(D[!(1_A)] \otimes 1_A)D[1_{!A}] \\
&= (D[!(1_A)] \otimes 1_A)D[1_{!A}] \\
&= (D[1_{!A}] \otimes 1_A)D[1_{!A}] \\
&= (1_{!A} \otimes \sigma_{A,A})(d_A \otimes 1_A)d_A
\end{aligned}$$

□

Proposition 4.7. [8] *Let $(\mathbb{X}, \otimes, K, \lambda, \rho, \sigma)$ be a differential category with a coalgebra modality $(!, \delta, \varepsilon, \Delta, e)$ and deriving transformation d . Then d induces a differential combinator D defined as:*

$$D[f] = d_A f$$

For every map $f : !A \rightarrow B$.

Proof. We must prove [D.A], [D.N] and [D.1] to [D.5]:

[D.A] We obtain additivity of the combinator by the fact that composition preserves addition:

$$D[f + g] = d_A(f + g) = d_A f + d_A g = D[f] + D[g]$$

[D.N] For naturality, suppose that the following square commutes:

$$\begin{array}{ccc} !A & \xrightarrow{f} & B \\ !(h) \downarrow & & \downarrow k \\ !C & \xrightarrow{g} & D \end{array}$$

Since \mathbf{d} is a natural transformation, we obtain the following equality:

$$(!(h) \otimes h)D[g] = (!(h) \otimes h)d_Cg = d_A!(h)g = d_Afk = D[f]k$$

[D.1] For the derivative of constants rule, we obtain the following equality by [d.1]:

$$D[e_A] = d_Ae_A = 0$$

[D.2] For the Rota-Baxter rule, we obtain the following equality by [d.2]:

$$\begin{aligned} D[\Delta_A(f \otimes g)] &= d_A\Delta_A(f \otimes g) \\ &= (\Delta_A \otimes 1_A)(1_{!A} \otimes \sigma_{A,!A})(d_A \otimes 1_{!A})(f \otimes g) + (\Delta_A \otimes 1_A)(1_{!A} \otimes d_A)(f \otimes g) \\ &= (\Delta_A \otimes 1_A)(1_{!A} \otimes \sigma_{A,!A})(D[f] \otimes g) + (\Delta_A \otimes 1_A)(f \otimes D[g]) \end{aligned}$$

[D.3] For the derivative of linear maps rule, we obtain the following equality by [d.3]:

$$D[\varepsilon_A f] = d_A\varepsilon_A f = (e_A \otimes 1_A)\lambda_A f$$

[D.4] For the derivative chain rule, we obtain the following equality by [d.4]:

$$\begin{aligned} D[\delta_A!(f)g] &= d_A\delta_A!(f)g \\ &= (\Delta_A \otimes 1_A)(\delta_A \otimes 1_{!A} \otimes 1_A)(1_{!(!A)} \otimes d_A)d_{!A}!(f)g \end{aligned}$$

$$\begin{aligned}
&= (\Delta_A \otimes 1_A)(\delta_A \otimes 1_{!A} \otimes 1_A)(1_{!(1A)} \otimes \mathbf{d}_A)(!(f) \otimes f)\mathbf{d}_B g \\
&= (\Delta_A \otimes 1_A)(\delta_A \otimes 1_{!A} \otimes 1_A)(!(f) \otimes \mathbf{D}[f])\mathbf{D}[g]
\end{aligned}$$

[D.5] For the independence rule, we obtain the following equality by [d.5]:

$$\begin{aligned}
(\mathbf{D}[!(g)] \otimes g)\mathbf{D}[f] &= ((\mathbf{d}_A!(g)) \otimes g)\mathbf{d}_B f \\
&= (\mathbf{d}_A \otimes 1_A)(!(g) \otimes g)\mathbf{d}_B f \\
&= (\mathbf{d}_A \otimes 1_A)\mathbf{d}_A(!(g) \otimes g) \\
&= (1_{!A} \otimes \sigma_{A,A})(\mathbf{d}_A \otimes 1_A)\mathbf{d}_A(!(g) \otimes g)f \\
&= (1_{!A} \otimes \sigma_{A,A})(\mathbf{d}_A \otimes 1_A)(!(g) \otimes g)\mathbf{d}_B f \\
&= (1_{!A} \otimes \sigma_{A,A})(\mathbf{D}[!(g)] \otimes g)\mathbf{D}[f]
\end{aligned}$$

□

Proposition 4.8. [8] For an additive symmetric monoidal category $(\mathbb{X}, \otimes, K, \lambda, \rho, \sigma)$ with a coalgebra modality $(!, \delta, \varepsilon, \Delta, e)$, the set of differential combinators $\mathbf{DiffComb}$ is isomorphic to the set of deriving transformations $\mathbf{DevTran}$. The isomorphism is given by the following pair of inverse functions:

$$\begin{aligned}
\psi : \mathbf{DiffComb} &\longrightarrow \mathbf{DevTran} \\
\mathbf{D} &\longmapsto \psi(\mathbf{D})_A = \mathbf{D}[1_{!A}] \\
\psi^{-1}(\mathbf{d})[f] &= \mathbf{d}f \longleftarrow \mathbf{d}
\end{aligned}$$

Therefore, the following are equivalent:

- (i) A differential category;
- (ii) An additive symmetric monoidal category with an algebra modality and a deriving transformation.

Proof. Proposition 4.6 and Proposition 4.7 imply that ψ and ψ^{-1} are well defined. Therefore, we need only show that these are inverses. For both directions, let $f : !A \rightarrow B$:

$$\begin{aligned}
\psi^{-1}(\psi(\mathbf{D}))[f] &= \psi(\mathbf{D})f & \psi(\psi^{-1}(\mathbf{d})) &= \psi^{-1}(\mathbf{d})[1_{!A}] \\
&= \mathbf{D}[1_{!A}]f & &= \mathbf{d}_A 1_{!A} \\
&= \mathbf{D}[f] & &= \mathbf{d}_A
\end{aligned}$$

The equivalence follows directly. □

4.4 Main Examples of Differential Categories

We finish this chapter by introducing our two main examples of differential categories. In fact, these two main examples are precisely our main examples of integral categories (Examples 3.13 and 3.15). This should come as no surprise, since we are working our way to showing these two examples are in fact examples of calculus categories, as we will see in Chapter 5 and prove in Chapter 6. We will simply give in detail the deriving transformation and not prove that these examples are in fact differential categories. Proofs can be found in [8].

Example 4.9. The category of sets and relations, \mathbf{REL} , has a differential category structure (see Section 2.5.1 in [8] for more details) where:

- (i) The additive symmetric monoidal structure $(\mathbf{REL}, \times, \{*\}, \pi_0, \pi_1, \sigma^\times)$ is the structure given by the cartesian product of sets and union of sets given in Example 2.3;
- (ii) The coalgebra modality $(!, \delta, \varepsilon, \Delta, e)$ is the finite bag comonad given in Example 2.8;
- (iii) The deriving transformation $\mathbf{d}_X : !(X) \times X \rightarrow !(X)$ is the relation which relates a bag and an element to a new bag obtained by adding the element to the original bag:

$$\mathbf{d}_X = \{((\llbracket x_1, \dots, x_n \rrbracket, x), \llbracket x, x_1, \dots, x_n \rrbracket) \mid x \in X\}, \llbracket x, x_1, \dots, x_n \rrbracket \in !(X) \subseteq (!(X) \times X) \times !(X)$$

Proposition 4.10. *The category of sets and relations is a differential category [8] with the structure and deriving transformation defined in Example 4.9.*

Proof. See Proposition 2.7 in [8]. □

Example 4.11. The category of vector spaces over a field \mathbb{K} , $\mathbf{VEC}_{\mathbb{K}}$, has a co-differential category (that is, $\mathbf{VEC}_{\mathbb{K}}^{Op}$ is a differential category) structure where:

- (i) The additive symmetric monoidal structure $(\mathbf{VEC}_{\mathbb{K}}, \otimes_{\mathbb{K}}, \mathbb{K}, \lambda, \rho, \sigma)$ is the structure given in Example 2.4 from the standard tensor product of vector spaces and the standard additive structure of vector spaces;
- (ii) The algebra modality $(\mathbf{Sym}, \eta, \mu, \nabla, u)$ is given by the free symmetric algebra monad given in Example 2.9;
- (iii) The deriving transformation $d_V : \mathbf{Sym}(V) \rightarrow \mathbf{Sym}(V) \otimes V$ on pure tensors is defined as follows:

$$d_V(v_1 \otimes \dots \otimes v_n) = \sum_{i=1}^n (v_1 \otimes \dots \otimes v_{i-1} \otimes v_{i+1} \otimes \dots \otimes v_n) \otimes v_i$$

which we then extend by linearity.

It is important to notice that this differential category structure on $\mathbf{VEC}_{\mathbb{K}}$ can be defined for any field \mathbb{K} , unlike the integral category structure described in Example 3.15, which required our field to have characteristic zero. In fact, the differential category structure for vector spaces can further be generalized to the category of modules over a ring.

As with when we introduced the integral category structure, there is an alternative approach of illustrating the differential category structure on $\mathbf{VEC}_{\mathbb{K}}$. We again make use of the isomorphism between the free symmetric algebra and the polynomial ring. Let $X = \{x_1, \dots\}$ be a basis of a vector space V , then the deriving transformation can be described on the

polynomial ring $d_V : \mathbb{K}[X] \rightarrow \mathbb{K}[X] \otimes V$ as follows on monomials:

$$d_V(x_1^{r_1} \dots x_n^{r_n}) = \sum_{i=1}^n r_i \cdot x_1^{r_1} \dots x_i^{r_i-1} \dots x_n^{r_n} \otimes x_i$$

which we then extend by linearity. Then the deriving transformation on a polynomial $p(x_1, \dots, x_n)$ can be described as taking the sum of partial derivatives of the polynomial in each of its variables. Which is explicitly given as follows:

$$d_V(p(x_1, \dots, x_n)) = \sum_{i=1}^n \frac{d p(x_1, \dots, x_n)}{d x_i} \otimes x_i$$

Proposition 4.12. *The category of vector spaces over the same field is a differential category [8] with the structure and deriving transformation defined in Example 4.11.*

Proof. See Proposition 2.9 in [8]. □

Chapter 5

Calculus Categories

One of the main goals of developing integral categories, apart from axiomatizing integration, was to obtain a categorical setting for calculus. Now that we have established integral categories and differential categories, we will combine these two notions simultaneously into a calculus category. However, a calculus category is not simply a category which is both an integral category and a differential category: we require integration and differentiation to be compatible with each other. In particular, we would like integration to be anti-differentiation. In the classical calculus setting, the relationship between integration and anti-differentiation is precisely expressed by the two fundamental theorems of calculus. The fundamental theorems explain to what extent integration and differentiation are inverse processes. Therefore, the extra axioms required for calculus categories will be to impose a similar relation between the deriving transformation and integral transformations by axiomatizing the two fundamental theorems.

The Second Fundamental Theorem of Calculus, which states that

$$\int_a^b \frac{df(t)}{dt}(t) dt = f(b) - f(a)$$

will be incorporated into calculus categories directly as an axiom, that is, will be expressed

as requiring that the deriving transformation d and the integral transformation s satisfy for each object A :

$$s_A d_A + !(0) = 1_{!A}$$

where $0 : A \rightarrow A$ is the zero map. This axiom is stated precisely in Definition 5.1, and interpreted immediately following the definition. A consequence of this axiom is that every differentiable map in a calculus category satisfies the Second Fundamental Theorem of Calculus.

The First Fundamental Theorem of Calculus, which states that

$$\frac{d(\int_a^t f(x) dx)}{dt}(x) = f(x)$$

will also be incorporated into one of the axioms of a calculus category. However, not every integrable map will satisfy the First Fundamental Theorem. Instead, the First Fundamental Theorem of Calculus is a property only certain integrable maps satisfy. In particular, in our example of the category of vector spaces and the free symmetric algebra, polynomials of more than one variable all satisfy the Second Fundamental Theorem but in general do not satisfy the First Fundamental Theorem with the differential given in Example 4.11 and integral given in Example 3.15. In fact, the same can be said about the category of sets and relations and the finite bag comonad. In light of this, the First Fundamental Theorem axiom for a calculus category is reinterpreted as the Poincaré condition which provides necessary and sufficient conditions for when a map satisfies the First Fundamental Theorem. The First Fundamental Theorem is explored in more details in Section 5.3 while the Poincaré condition is defined in Definition 5.11.

We begin this chapter with a section on the Second Fundamental Theorem of Calculus. The following section is dedicated to an alternative and equivalent description of the second

fundamental theorem by introducing the compatibility and Taylor conditions. We then move onto the first fundamental theorem and afterwards, we discuss the Poincaré condition. Finally, the last section of this chapter is dedicated to giving the definition of calculus category and returning to our two main examples of calculus categories, the category vector spaces and the category of sets and relations.

5.1 Second Fundamental Theorem of Calculus

In this section we define what it means for a deriving transformation and integral transformation to satisfy the Second Fundamental Theorem of Calculus. First, we will give the definition and afterwards we will explain the intuition.

Definition 5.1. Let $(\mathbb{X}, \otimes, K, \lambda, \rho, \sigma)$ be a differential category and integral category on the same coalgebra modality $(!, \delta, \varepsilon, \Delta, e)$ with a differential combinator D (or equivalently a deriving transformation \mathbf{d}) and integral combinator S (or equivalently an integral transformation \mathbf{s}). The differential combinator D and the integral combinator S are said to satisfy the **Second Fundamental Theorem of Calculus** if for every map differentiable map $f : !A \rightarrow B$:

$$S[D[f]] + !(0)f = f$$

where $0 : A \rightarrow A$. Or equivalently the deriving transformation \mathbf{d} and the integral transformation \mathbf{s} satisfy the **Second Fundamental Theorem of Calculus** if for each object $A \in Ob(\mathbb{X})$:

$$\mathbf{s}_A \mathbf{d}_A + !(0) = 1_{!A}$$

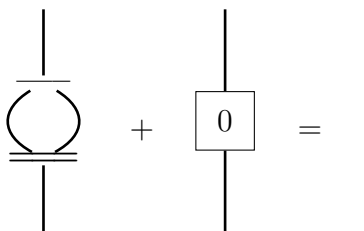

where $0 : A \rightarrow A$.

It is important to note that in general, $!(0_{A,B}) : !A \rightarrow !B$ is not equal to $0_{!A,!B} : !A \rightarrow !B$. In particular, this is the case for both our main examples of coalgebra modalities.

Example 5.2. Recall that the zero map $0_{X,Y} : X \rightarrow Y$ for the additive structure of REL defined in Example 2.3 is the empty set $0_{X,Y} = \emptyset$. For the finite bag functor $! : \text{REL} \rightarrow \text{REL}$, defined in Example 2.8, $!(\emptyset) = !(X) \rightarrow !(Y)$ is the relation which relates the empty bag in $!(X)$ to the empty bag in $!(Y)$:

$$!(\emptyset) = \{([\] , [\])\} \subset !(X) \times !(Y)$$

and so $!(\emptyset)$ is not the empty set.

Example 5.3. For the free symmetric algebra functor $\text{Sym} : \text{VEC}_{\mathbb{K}} \rightarrow \text{VEC}_{\mathbb{K}}$, defined in Example 2.9, $\text{Sym}(0) : \text{Sym}(V) \rightarrow \text{Sym}(W)$ for pure tensors is defined as follows:

$$\text{Sym}(0)(w) = \begin{cases} w & \text{if } w \in \text{Sym}^0(V) = \mathbb{K} \\ 0 & \text{o.w.} \end{cases}$$

which we then extend by linearity. Therefore, $\text{Sym}(0)$ is not equal to the zero map.

Since we are working in an additive category, we do not assume that we have negatives. Therefore, we must re-express the statement of the second fundamental theorem as follows:

$$\int_a^b \frac{df(t)}{dt}(x) dt + f(a) = f(b)$$

Recall also that our integral combinator is to be naively thought as the operator whose output is the integral of function from zero to x . Therefore, we expect our lower bound in the expression of the Second Fundamental Theorem of Calculus to be zero. This is recaptured by precomposing with $!0$, that is, $!0f$ should be thought of as the map f evaluated at zero.

Then in terms of classical calculus, we obtain the following:

$$S[D[f]](x) + !(0)f = \int_0^x \frac{df(t)}{dt}(t) dt + f(0) = f(x)$$

In the following section we will see how the Second Fundamental Theorem of Calculus is equivalent to the deriving transformation and integral transformation satisfying two other conditions.

5.2 Compatibility and Taylor

In this section, we introduce the Compatibility and Taylor conditions for integral transformations and deriving transformations. We begin by giving the definitions of these conditions and then giving some intuition. Then we will prove that these two conditions are equivalent to satisfying the Second Fundamental Theorem of Calculus. We begin by defining when an integral transformation and deriving transformation are compatible.

Definition 5.4. Let $(\mathbb{X}, \otimes, K, \lambda, \rho, \sigma)$ be differential category and integral category on the same coalgebra modality $(!, \delta, \varepsilon, \Delta, e)$ with differential combinator D (or equivalently deriving transformation d) and integral combinator S (or equivalently integral transformation s). The differential combinator D and the integral combinator S are said to be **compatible** if for every differentiable map $f : !A \rightarrow B$:

$$D[S[D[f]]] = D[f]$$

We also call this equality **Compatibility** of D and S . Equivalently, the deriving transformation d and the integral transformation s are said to be **compatible** if for each object $A \in Ob(\mathbb{X})$:

$$d_A s_A d_A = d_A$$

We also call this equality **compatibility** of \mathbf{d} and \mathbf{s} .

Simply put, compatibility is a weaker version of the Second Fundamental Theorem of Calculus. In fact, if one differentiates the equation of the Second Fundamental Theorem of Calculus, since the derivative of a constant is zero (as a map evaluated at zero is a constant), one obtains the expression for compatibility.

We next define the Taylor condition, which unlike compatibility and the fundamental theorems, is property of only the deriving transformation.

Definition 5.5. Let $(\mathbb{X}, \otimes, K, \lambda, \rho, \sigma)$ be differential category with coalgebra modality $(!, \delta, \varepsilon, \Delta, e)$ and differential combinator \mathbf{D} (or equivalently deriving transformation \mathbf{d}). The differential combinator \mathbf{D} is **Taylor** if for every parallel pair of differentiable maps $f, g : !A \rightrightarrows B$ with $\mathbf{D}[f] = \mathbf{D}[g]$ then:

$$f + !(0)g = g + !(0)f$$

where $0 : A \rightarrow A$. Equivalently, the deriving transformation \mathbf{d} is **Taylor** if for every pair of differentiable maps $f, g : !A \rightarrow B$, if $\mathbf{d}_A f = \mathbf{d}_A g$ then:

$$f + !(0)g = g + !(0)f$$

where $0 : A \rightarrow A$.

The Taylor property is analogous to the statement that if the derivatives of two maps are equal, then those two maps differ by constants. In this case, the constants are the maps evaluated at zero. If one assumes that we can subtract maps, that is, if we have negatives,

then the Taylor property is equivalent to the statement that if the derivative of a map is zero then it is a constant. The Taylor condition was the extra condition Ehrhard required of his differential transformation to obtain the Second Fundamental Theorem of Calculus with his integral transformation [15].

In the following proposition, we will show that the Second Fundamental Theorem of Calculus is equivalent to the compatibility and the Taylor conditions combined.

Proposition 5.6. *For a differential combinator \mathbf{D} and an integral combinator \mathbf{s} (or equivalently a deriving transformation \mathbf{d} and an integral transformation \mathbf{s}) on the same coalgebra modality, the following are equivalent:*

- (i) \mathbf{D} and \mathbf{S} (or equivalently \mathbf{d} and \mathbf{s}) satisfy the Second Fundamental Theorem of Calculus;
- (ii) \mathbf{D} and \mathbf{S} (or equivalently \mathbf{d} and \mathbf{s}) are Compatible and \mathbf{D} (or equivalently \mathbf{d}) is Taylor.

Proof. We will prove this proposition using the deriving transformation and the integral transformation.

(i) \Rightarrow (ii): Suppose \mathbf{d} and \mathbf{s} satisfy the Second Fundamental Theorem of Calculus. To prove that \mathbf{d} is taylor, suppose that $\mathbf{d}_A f = \mathbf{d}_A g$ for parallel maps $f, g : !A \rightrightarrows B$. Then we have the following equality:

$$\begin{aligned}
f + !(0)g &= (\mathbf{s}_A \mathbf{d}_A + !(0))f + !(0)g && \text{(2nd Fundamental Theorem)} \\
&= \mathbf{s}_A \mathbf{d}_A f + !(0)f + !(0)g && \text{(Additive Structure)} \\
&= \mathbf{s}_A \mathbf{d}_A g + !(0)f + !(0)g && (\mathbf{d}_A f = \mathbf{d}_A g) \\
&= (\mathbf{s}_A \mathbf{d}_A + !(0))g + !(0)f && \text{(Additive Structure)} \\
&= g + !(0)f
\end{aligned}$$

Next we prove that \mathbf{d} and \mathbf{s} are compatible:

$$\begin{aligned}
\mathbf{d}_A &= \mathbf{d}_A(\mathbf{s}_A \mathbf{d}_A + !(0)) && \text{(2nd Fundamental Theorem)} \\
&= \mathbf{d}_A \mathbf{s}_A \mathbf{d}_A + \mathbf{d}_A !(0) && \text{(Additive Structure)} \\
&= \mathbf{d}_A \mathbf{s}_A \mathbf{d}_A + (!(0) \otimes 0) \mathbf{d}_A && \text{(Naturality of } \mathbf{d} \text{)} \\
&= \mathbf{d}_A \mathbf{s}_A \mathbf{d}_A + 0 && \text{(Additive Structure)} \\
&= \mathbf{d}_A \mathbf{s}_A \mathbf{d}_A
\end{aligned}$$

(i) \Rightarrow (ii): Suppose \mathbf{d} and \mathbf{s} are compatible and \mathbf{d} is Taylor. Notice that by the definition of compatibility we have that $\mathbf{d}_A \mathbf{s}_A \mathbf{d}_A = \mathbf{d}_A$ and so by Taylor we have,

$$\mathbf{s}_A \mathbf{d}_A + !(0) = 1_{!A} + !(0) \mathbf{s}_A \mathbf{d}_A$$

However by naturality of the integral transformation, we have the following equality:

$$\begin{aligned}
\mathbf{s}_A \mathbf{d}_A + !(0) &= 1_{!A} + !(0) \mathbf{s}_A \mathbf{d}_A \\
&= 1_{!A} + \mathbf{s}_A (!(0) \otimes 0) \mathbf{d}_A && \text{(Naturality of } \mathbf{s} \text{)} \\
&= 1_{!A} + 0 && \text{(Additive Structure)} \\
&= 1_{!A}
\end{aligned}$$

□

5.3 First Fundamental Theorem of Calculus

Recall that unlike the Second Fundamental Theorem of Calculus, the First Fundamental Theorem of Calculus holds for only certain integrable maps. This situation is drastically different than classical calculus. In particular, in the introduction we explained that for the example of the category of vector spaces and the free symmetric algebra, polynomials

of more than one variable often do not satisfy the First Fundamental Theorem of Calculus (see Example 5.8 below). In this section we define what it means for certain integrable maps to satisfy the First Fundamental Theorem of Calculus. We then give the definition of calculus objects, which are objects with the property that the identity map satisfies the First Fundamental Theorem of Calculus.

Definition 5.7. Let $(\mathbb{X}, \otimes, K, \lambda, \rho, \sigma)$ be a differential category and an integral category on the same coalgebra modality $(!, \delta, \varepsilon, \Delta, e)$, with a differential combinator D (or equivalently a deriving transformation d) and an integral combinator S (or equivalently an integral transformation s). An integrable map $f : !A \otimes A \rightarrow B$ satisfies the **First Fundamental Theorem of Calculus** if $D[S[f]] = f$ or equivalently $d_A s_A f = f$.

In string diagram notation, an integrable map f satisfying the First Fundamental Theorem of Calculus is given by:

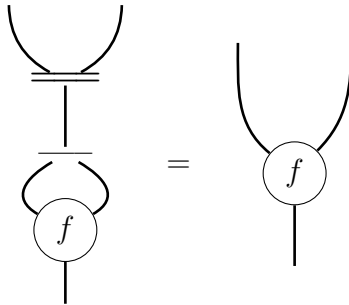

The combinator notation for satisfying the First Fundamental Theorem of Calculus should make it clear that this is the correct interpretation of the concept. One does not have to go looking very far in either of our two main examples, REL and $\text{VEC}_{\mathbb{K}}$, to find examples of integrable maps which do not satisfy the First Fundamental Theorem of Calculus.

Example 5.8. Let V be a vector space of dimension 2 over a field of characteristic zero \mathbb{K} with basis $\{x, y\}$. Consider the integrable map $f : \mathbb{K} \rightarrow \text{Sym}(V) \otimes V$ which maps 1 to the pure tensor $x \otimes y \in \text{Sym}(V) \otimes V$. Applying first the integral transformation s from example

Example 3.15 and then the deriving transformation from Example 4.11, we obtain:

$$\mathbf{d}_V(\mathbf{s}V(f(1)))\mathbf{d}_V(\mathbf{s}V(x \otimes y)) = \mathbf{d}_V\left(\frac{1}{2} \cdot x \otimes y\right) = \frac{1}{2} \cdot x \otimes y + \frac{1}{2} \cdot y \otimes x \neq x \otimes y = f(1)$$

So f does not satisfy the First Fundamental Theorem of Calculus. If this example appears backwards, recall that $\mathbf{VEC}_{\mathbb{K}}^{\text{Op}}$ is the differential and integral category.

In the following proposition, we give a consequence of satisfying the First Fundamental Theorem of Calculus, which will be important in the following section.

Proposition 5.9. *Let $(\mathbb{X}, \otimes, K, \lambda, \rho, \sigma)$ be a differential category and an integral category on the same coalgebra modality $(!, \delta, \varepsilon, \Delta, e)$, with a differential combinator \mathbf{D} (or equivalently a deriving transformation \mathbf{d}) and an integral combinator \mathbf{S} (or equivalently an integral transformation \mathbf{s}). If an integrable map $f : !A \otimes A \rightarrow B$ satisfies the First Fundamental Theorem of Calculus, then $(1 \otimes \sigma_{A,A})(\mathbf{d}_A \otimes 1_A)f = (\mathbf{d}_A \otimes 1_A)f$ (written in string diagrams below).*

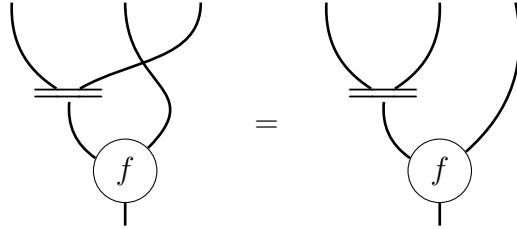

Proof. Since $\mathbf{d}_A \mathbf{s}_A f = f$, then by [d.5] we have the following equality:

$$(1 \otimes \sigma_{A,A})(\mathbf{d}_A \otimes 1_A)f = (1 \otimes \sigma_{A,A})(\mathbf{d}_A \otimes 1_A)\mathbf{d}_A \mathbf{s}_A f = (\mathbf{d}_A \otimes 1_A)\mathbf{d}_A \mathbf{s}_A f = (\mathbf{d}_A \otimes 1_A)f$$

□

Now we give the definition of a calculus object. These are objects where the identity of $!A \otimes A$ satisfies the First Fundamental Theorem of Calculus, which is another way of saying that the deriving transformation and integral transformation satisfy it.

Definition 5.10. Let $(\mathbb{X}, \otimes, K, \lambda, \rho, \sigma)$ be a differential category and an integral category on the same coalgebra modality $(!, \delta, \varepsilon, \Delta, e)$, with a differential combinator D (or equivalently a deriving transformation d) and an integral combinator S (or equivalently an integral transformation s). A **calculus object** is an object A such that the identity map $1_{!A \otimes A}$ satisfies the First Fundamental Theorem of Calculus. Equivalently, a calculus object is an object A such that the deriving transformation d_A and the integral transformation s_A satisfy the **First Fundamental Theorem of Calculus**, that is:

$$[\mathbf{f.1}] \quad d_A s_A = 1_{!A \otimes A}.$$

This assures us that any integrable map with domain $!A \otimes A$, where A is a calculus object, will satisfy the First Fundamental Theorem of Calculus.

5.4 Poincaré Condition

In this section we introduce the Poincaré Condition. The Poincaré Condition states that if an integrable map satisfies a certain hypothesis, then it satisfies the First Fundamental Theorem of Calculus. The name of the condition comes from the Poincaré Lemma from cohomology [35] and differential topology [6], which states an analogous result of giving criteria for a map to be an antiderivative.

We begin with the definition of the Poincaré Condition. We then give consequences the Poincaré Condition including that the deriving transformation and integral transformation are compatible and the fact that the monoidal unit is a calculus object.

Definition 5.11. An integrable map $f : !A \otimes A \rightarrow B$ satisfies the **Poincaré pre-condition** if the following equality holds:

$$(1 \otimes \sigma_{A,A})(d_A \otimes 1_A)f = (d_A \otimes 1_A)f$$



The deriving transformation \mathbf{d} and the integral transformation \mathbf{s} are said to satisfy the **Poincaré condition** if for each integrable map $f : !A \otimes A \rightarrow B$ which satisfies the Poincaré pre-condition, then f satisfies the First Fundamental Theorem of Calculus, that is, $\mathbf{d}_A \mathbf{s}_A f = f$.

Notice that Proposition 5.9 states that if an integrable map satisfies the First Fundamental Theorem of Calculus, then it satisfies the Poincaré pre-condition. Therefore when a deriving transformation and integral transformation satisfy the Poincaré condition, we obtain necessary and sufficient condition for an integrable map to satisfy the First Fundamental Theorem of Calculus.

We now prove that the Poincaré Condition implies that the deriving transformation and integral transformation are compatible. Therefore, as a consequence, the Poincaré Condition and that the deriving transformation is Taylor imply the Second Fundamental Theorem of Calculus.

Proposition 5.12. *A deriving transformation \mathbf{d} and an integral transformation \mathbf{s} which satisfy the Poincaré condition are Compatible.*

Proof. By [d.5], for each object A , the deriving transformation \mathbf{d}_A satisfies the Poincaré pre-condition that $(1 \otimes \sigma_{A,A})(\mathbf{d}_A \otimes 1_A)\mathbf{d}_A = (\mathbf{d}_A \otimes 1_A)\mathbf{d}_A$. Therefore, \mathbf{d}_A satisfies the First fundamental theorem of Calculus, which is simply the statement of Compatibility:

$$\mathbf{d}_A \mathbf{s}_A \mathbf{d}_A = \mathbf{d}_A$$

□

Corollary 5.13. *A deriving transformation \mathbf{d} and an integral transformation \mathbf{s} which satisfy the Poincaré condition such that \mathbf{d} is Taylor, satisfies the Second Fundamental Theorem of Calculus.*

Proof. The Poincaré condition implies Compatibility. The Second Fundamental Theorem of Calculus follows since it is equivalent to Compatibility and Taylor by Proposition 5.6. \square

Next we prove the relation of the Poincaré Condition to calculus objects. We first give necessary conditions for being a calculus object in the presence of the Poincaré Condition, which in particular shows that the monoidal unit is always a calculus object.

Proposition 5.14. *Let $(\mathbb{X}, \otimes, K, \lambda, \rho, \sigma)$ be a differential category and integral category on the same coalgebra modality $(!, \delta, \varepsilon, \Delta, e)$ with deriving transformation \mathbf{d} and integral transformation \mathbf{s} which satisfy the Poincaré condition. If A is an object such that $\sigma_{A,A} = 1_{A \otimes A}$, then A is a calculus object.*

Proof. Since $\sigma_{A,A} = 1_{A \otimes A}$, the Poincaré pre-condition is true trivially for the identity $1_{A \otimes A}$. Therefore, $\mathbf{d}_A \mathbf{s}_A = 1_{!A \otimes A}$. \square

Corollary 5.15. *If the Poincaré condition is satisfied, then the monoidal unit K is a calculus object.*

Proof. By coherence of symmetric monoidal categories [29, 26], $\sigma_{K,K} = 1_{K \otimes K}$. Therefore, K is a calculus object. \square

We now show that if for some object A , ε_A is a retraction, then in fact Proposition 5.14 gives necessary and sufficient conditions for the object A to be a calculus object.

Proposition 5.16. *Let $(\mathbb{X}, \otimes, K, \lambda, \rho, \sigma)$ be a differential category and integral category on the same coalgebra modality $(!, \delta, \varepsilon, \Delta, e)$ with deriving transformation \mathbf{d} and integral transformation \mathbf{s} which satisfy the Poincaré condition. If for an object $A \in \mathbb{X}$, ε_A is a retraction, then the following are equivalent:*

(i) $\sigma_{A,A} = 1_{A \otimes A}$;

(ii) A is a calculus object.

Proof. By Proposition 5.14, $i) \Rightarrow ii)$ is always true in the presence of the Poincaré Condition. For the other direction $ii) \Rightarrow i)$, let η_A be a section of ε_A and suppose that A is a calculus object, that is, $\mathbf{d}_A \mathbf{s}_A = 1_{A \otimes A}$. To show that $\sigma_{A,A} = 1_{A \otimes A}$ we will need to use the case $n = 1$ of Proposition 3.18 (recall that $\omega_{(0\ 1)} = \sigma$):

$$\begin{aligned}
 1_{A \otimes A} &= (\eta_A \otimes 1_A)(\varepsilon_A \otimes 1_A) \\
 &= (\eta_A \otimes 1_A) \mathbf{d}_A \mathbf{s}_A (\varepsilon_A \otimes 1_A) && (A \text{ is a calculus object}) \\
 &= (\eta_A \otimes 1_A) \mathbf{d}_A \mathbf{s}_A (\varepsilon_A \otimes 1_A) \sigma_{A,A} && (\text{Prop. 3.18}) \\
 &= (\eta_A \otimes 1_A)(\varepsilon_A \otimes 1_A) \sigma_{A,A} \\
 &= \sigma_{A,A}
 \end{aligned}$$

□

5.5 Calculus Category

In this section, we finally give the definition of a calculus category. After giving the definition, we will also demonstrate our two main examples as calculus categories. We will not prove that these examples are in fact calculus categories in this section, we will do so in Chapter 6. In fact we will see in Chapter 6 that the calculus category structure given in these examples are induced by an antiderivative. Categories with antiderivatives are a special case of a calculus category. In Table 5.1 we collect the important identities for a calculus category and their classical calculus analogues. We now give the definition of a calculus category.

Definition 5.17. A **calculus category** is a differential category and an integral category on the same coalgebra modality such that the deriving transformation and the integral transformation satisfy the Second Fundamental Theorem of Calculus and the Poincaré condition.

Name	Equation	Calculus Analogue
Second Fundamental Theorem	$sd + !(0) = 1$	$\int_0^b \frac{df(t)}{dt}(x) dx + f(0) = f(b)$
Compatibility	$dsd = d$	$\frac{\int_0^y \frac{df(t)}{dt}(u) du}{dy}(x) = \frac{df(t)}{dt}(x)$
Taylor	$df = dg$ $\Rightarrow f + !(0)g = g + !(0)f$	$\frac{df(t)}{dt} = \frac{dg(t)}{dt}$ $\Rightarrow f + C = g$
First Fundamental Theorem	$dsf = f$	$\frac{d(\int_0^t f(u) du)}{dt}(x) = f(x)$
Poincaré Condition	$(1 \otimes \sigma)(d \otimes 1)f = (d \otimes 1)f$ $\Leftrightarrow dsf = f$	$f' dydz = f' dzdy$ $\Leftrightarrow \frac{d(\int_0^t f(u) du)}{dt}(x) = f(x)$

Table 5.1: Properties for Calculus Categories

It is important to note that by Corollary 5.13, an equivalent definition of a calculus category would simply require the Poincaré Condition and that the deriving transformation is Taylor. Now we give our two main examples of calculus categories, which are also our two main examples of integral and differential categories.

Example 5.18. The category of sets and relations, \mathbf{REL} , with the integral structure defined in Example 3.13 and the differential structure defined in Example 4.9 is a calculus category. Furthermore, the only calculus objects of this calculus category structure for \mathbf{REL} are one element sets, in particular the chosen singleton set $\{*\}$ and the empty set.

Proposition 5.19. *The category of sets and relations with the structure, deriving transformation and integral transformation defined above is a calculus category.*

Example 5.20. The category of vector spaces over a field of characteristic zero \mathbb{K} , $\mathbf{VEC}_{\mathbb{K}}$, with the integral structure defined in Example 3.15 and the differential structure defined in Example 4.11 is a calculus category. Furthermore, the only calculus objects of this calculus category structure for $\mathbf{VEC}_{\mathbb{K}}$ are one dimensional vector spaces, in particular the field \mathbb{K} , and the zero vector space.

Proposition 5.21. *The category of vector spaces over the same field of characteristic zero is a calculus category with the structure, deriving transformation and integral transformation defined above is a calculus category.*

Chapter 6

From a Differential Category to a Calculus Category

In this chapter, we will explore when a differential category is also a calculus category. The particular conditions which we will study are in fact quite simple to state. There are two natural transformations called J and K which all differential categories have. When J and K are in fact natural isomorphisms, then the differential category is a calculus category. The main goal of this chapter is to prove this statement. We say that a differential category has antiderivatives if K is a natural isomorphism.

As discussed in the introduction of this thesis, observations and ideas of T. Ehrhard [15] inspired this approach. Recall that T. Ehrhard observed that in certain $*$ -autonomous categories which are in fact differential categories, it is possible with one additional assumption to compute antiderivatives [15]. The additional assumption is that the natural transformation J , constructed from the deriving transformation, is a natural isomorphism. With this assumption, Ehrhard constructed an integral transformation using J^{-1} and was able to prove that this integral transformation satisfied the Poincaré Condition. When the deriving transformation is Taylor, the deriving transformation and the integral transformation also

satisfy the Second Fundamental Theorem of Calculus. However, Ehrhard's construction of an integral transformation without the Taylor property does not satisfy our requirements (see Definition 3.9), as it fails both the Rota-Baxter rule and the independence rule. To obtain our notion of an integral transformation, we must strengthen Ehrhard's approach. We start by insisting that a slightly different natural transformation, which we call \mathbf{K} , should be invertible in order to obtain an integral transformation. This more fundamental transformation not only produces an integral transformation, but also secures the Second Fundamental Theorem of Calculus and the Poincaré's condition. It also ensures that Ehrhard's transformation \mathbf{J} is invertible. The converse is not true: if \mathbf{J} is then \mathbf{K} need not be invertible. However, in the presence of the Taylor Property, the invertibility of \mathbf{J} implies the invertibility of \mathbf{K} . Furthermore, it is important to observe that the integral transformation produced by the inverse of \mathbf{K} is the same as that produced by the inverse of \mathbf{J} (when \mathbf{K} is already invertible). With this observation, Ehrhard's form of antiderivative remains very useful in the proof of the Poincaré's condition. Then a differential category with anti-derivatives, given by requiring \mathbf{K} to be invertible, gives a calculus category.

The sections in this chapter are grouped into two formats: sections on certain natural transformations and sections where we prove certain property of the calculus category structure. The sections on natural transformations all follow the same format: we define the natural transformation and then provide various properties it satisfies. This chapter is organized in the following manner. We begin by introducing the coderiving transformation. This is an important natural transformation throughout this chapter and to the theory of antiderivatives, as every other natural transformation we will construct in this chapter (\mathbf{W} , \mathbf{L} , \mathbf{K} and \mathbf{J}) will be constructed from it. We then define the \mathbf{W} , whose main importance is for simplifying calculations throughout the remaining chapter. Then we introduce \mathbf{L} , \mathbf{K} and \mathbf{J} and their inverses \mathbf{K}^{-1} and \mathbf{J}^{-1} . Next we prove that \mathbf{K} is invertible if and only if \mathbf{J} is invertible and the deriving transformation is Taylor. Finally, we end this chapter by proving that

differential categories where J and K are natural isomorphisms are in fact calculus categories.

Throughout this chapter, we will make heavy use of the graphical calculus: almost all proofs will be done using string diagrams. Hopefully, this chapter will further convince the reader the of full power and beauty of the graphical calculus.

6.1 The Coderiving Transformation and the W Map

In this section we introduce the coderiving transformation and the W Map, natural transformations all differential categories have. The coderiving transformation is probably one's first attempt at constructing an integral transformation using only the structure of a differential category, as it has the same domain and codomain as the integral transformation. However, in Proposition 6.4 we will see that the coderiving transformation actually fails the Rota-Baxter Rule [s.2]. The coderiving transformation will be essential throughout this chapter and to building an integral transformation. The W-Map is constructed using the deriving and coderiving transformations. The main purpose of the W-Map will be to simplify proofs and in particular prove that the integral transformation we will construct satisfies the Poincaré condition.

We begin with the definition of the coderiving transformation and give the string diagram notation. We then give examples of the coderiving transformation in both of our main examples of calculus categories. We then provide many properties of the coderiving transformation in Proposition 6.4, which we will often use throughout the rest of the chapter. Afterwards, we give the definition and the string diagram notation for the W-Map. We finish this section with Proposition 6.6, which we will use often in the rest of the chapter.

Definition 6.1. Let $(\mathbb{X}, \otimes, K, \lambda, \rho, \sigma)$ be an additive symmetric monoidal category with a coalgebra modality $(!, \delta, \varepsilon, \Delta, e)$. The **coderiving transformation** is the natural transfor-

mation \mathbf{d}° with components $\mathbf{d}_A^\circ : !A \rightarrow !A \otimes A$ defined as:

$$\mathbf{d}_A^\circ = \Delta_A(1_{!A} \otimes \varepsilon_A)$$

The string diagram notation for the coderiving transformation is given by flipping the deriving transformation horizontally:

$$\mathbf{d}^\circ := \begin{array}{c} | \\ \hline \hline \cup \\ \cup \end{array} = \begin{array}{c} | \\ \triangle \\ \cup \\ \cup \end{array} \begin{array}{c} \varepsilon \\ | \end{array}$$

Before giving some properties of the coderiving transformation, we give explicit descriptions of the coderiving transformations in our main examples of additive symmetric monoidal categories with a coalgebra modality.

Example 6.2. In \mathbf{REL} for the finite bag coalgebra modality (see Example 2.8), the coderiving transformation of a set X is the relation which relates a bag to the a new bag where we pulled out a element of the original bag:

$$\mathbf{d}_X^\circ = \{(B, (B - \{x\}, x)) \mid B \in !(X), x \in B\} \subseteq !(X) \times (!(X) \times X)$$

Notice that in \mathbf{REL} the coderiving transformation is equal to the integral transformation!

Example 6.3. In $\mathbf{VEC}_{\mathbb{K}}$ for the free symmetric algebra modality (see Example 2.9), the coderiving transformation for a vector space V is simply the concatenation of a letter (an element of V) and a word (a pure tensor of $\mathbf{Sym}(V)$). On pure tensors, the coderiving transformation is given explicitly as follows:

$$\mathbf{d}_V^\circ((v_1 \otimes \dots \otimes v_n) \otimes v) = v_1 \otimes \dots \otimes v_n \otimes v$$

which we extend by linearity. If this example appears backwards, recall that $\mathbf{VEC}_{\mathbb{K}}^{\text{Op}}$ is the dif-

ferential category. Notice that in $\mathbf{VEC}_{\mathbb{K}}$, the coderivative is NOT the integral transformation since it is missing a factor of $\frac{1}{n+1}$.

These examples show that the coderiving transformation appears to be very close to being an integral transformation. In fact, the properties which the coderiving transformation satisfy are extremely closely related to the axioms of an integral transformation. In the following proposition, we give some of these properties.

Proposition 6.4. *The coderivative d° satisfies the following properties (see Table 6.1 for string diagrams) for each object $A \in \mathbf{Ob}(\mathbb{X})$:*

$$[\mathbf{cd.1}] \quad d_A^\circ(e_A \otimes 1_A)\lambda_A = \varepsilon_A$$

$$[\mathbf{cd.2}] \quad d_A^\circ(\varepsilon_A \otimes 1_A) = \Delta_A(\varepsilon_A \otimes \varepsilon_A)$$

$$[\mathbf{cd.3}] \quad d_A^\circ(\Delta_A \otimes 1_A) = \Delta_A(1_{!A} \otimes d_A^\circ)$$

$$[\mathbf{cd.4}] \quad d_A^\circ(\Delta_A \otimes 1_A)(1_{!A} \otimes \sigma_{A,A}) = \Delta_A(d_A^\circ \otimes 1_{!A})$$

$$[\mathbf{cd.5}] \quad 2 \cdot \Delta_A(d_A^\circ \otimes d_A^\circ) = d_A^\circ(\Delta_A \otimes 1_A)(d_A^\circ \otimes 1_{!A} \otimes 1_A) + d_A^\circ(\Delta_A \otimes 1_A)(1_{!A} \otimes \sigma_{A,!A})(1_{!A} \otimes 1_A \otimes d_A^\circ)$$

$$[\mathbf{cd.6}] \quad d_A^\circ(\delta_A \otimes 1_A) = \delta_A d_A^\circ(1_{!(!A)} \otimes \varepsilon_{!A})$$

$$[\mathbf{cd.7}] \quad d_A^\circ(d_A^\circ \otimes 1_A) = d_A^\circ(d_A^\circ \otimes 1_A)(1_{!A} \otimes \sigma_{A,A})$$

Proof. Most of these properties follow from the coalgebra modality structure:

[cd.1]: Here we use the counit of the comultiplication:

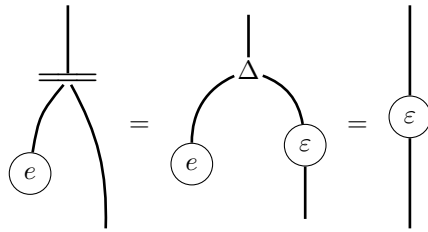

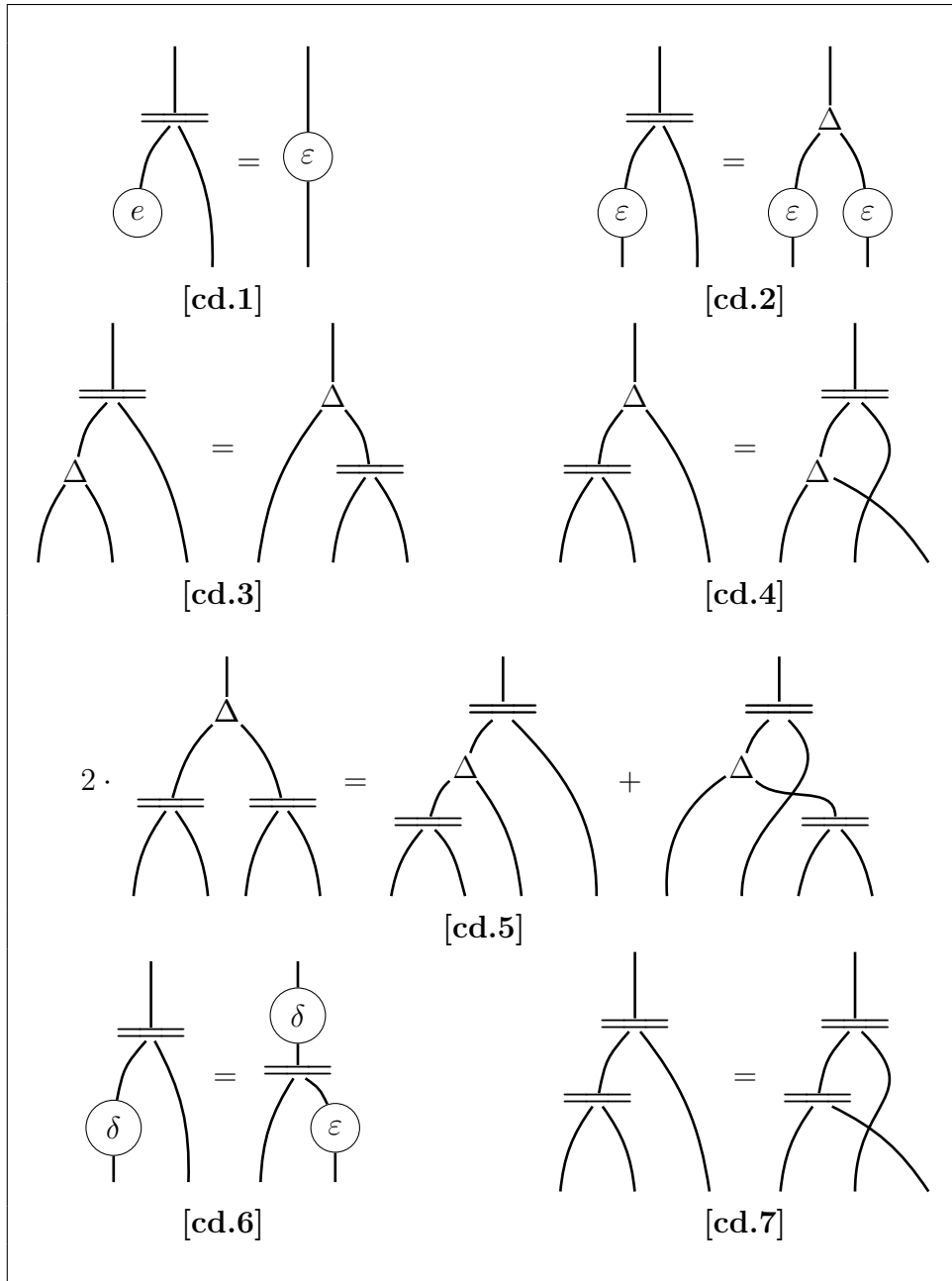
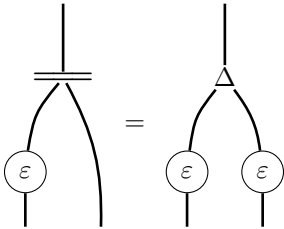
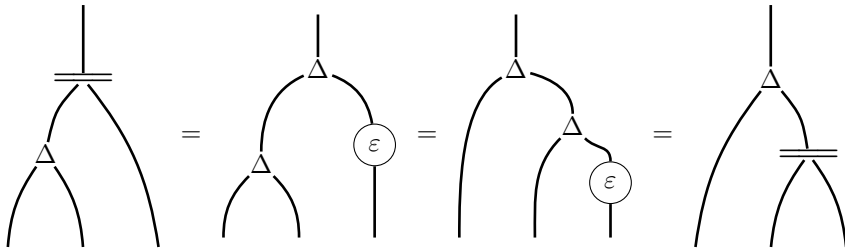

Table 6.1: Properties of the coderiving transformation

[cd.2]: By definition of the coderiving transformation:



[cd.3]: Here we use the coassociativity of the comultiplication:



[cd.4]: Here we use the cocommutativity of the comultiplication:

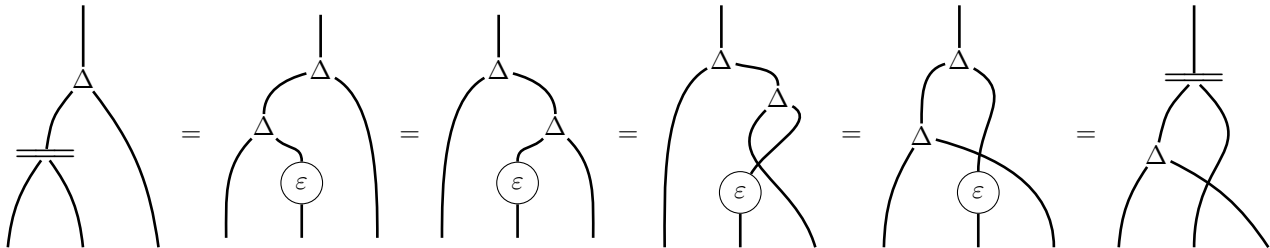

[cd.5]: Here we use [cd.3] for the first one on the left and [cd.4] for the second one on the left:

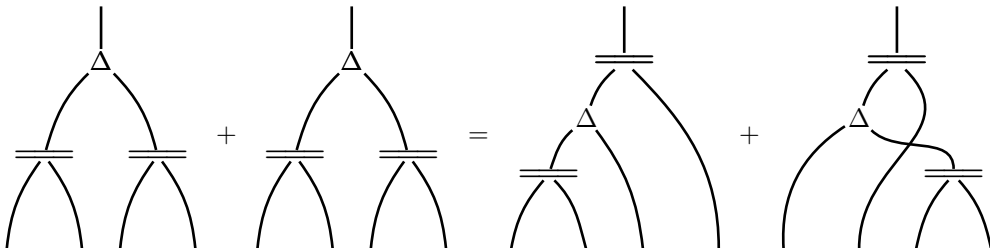

[cd.6]: Here we use the comonad triangle identity and that δ is a coalgebra map:

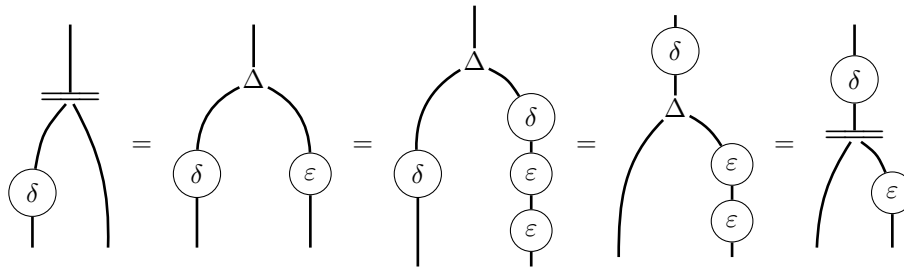

[cd.7]: Here we use [cd.4]:

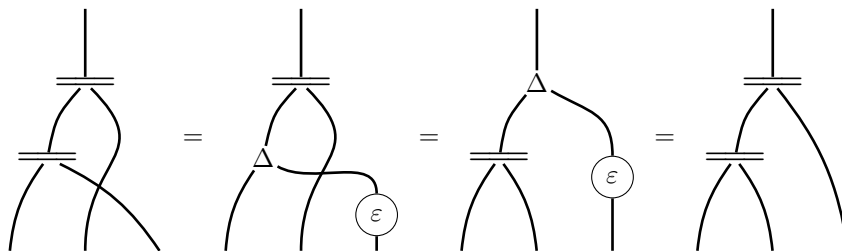

□

Note the similarities between the three coderiving transformation properties [cd.1], [cd.5] and [cd.7] and the integral transformation axioms. The first property [cd.1] and the last property [cd.7] mirror precisely the integral of a constant axiom and independence of integration axiom respectively. However [cd.5] and the Rota-Baxter rule axiom differ by a factor of 2. There is an easy fix to this problem: one can simply ask that the hom-sets of our category be idempotent commutative monoids [20], that is, categories which satisfy $1 + 1 = 1$ (the last example of Section 7.2 briefly discusses this). In fact, one of our main examples, REL, is an example of this phenomenon.

In the following sections, we will construct an integral transformation using the coderiving transformation. Next we move on to studying the W map.

Definition 6.5. Let $(\mathbb{X}, \otimes, K, \lambda, \rho, \sigma)$ be a differential category with coalgebra modality $(!, \delta, \varepsilon, \Delta, e)$ and deriving transformation d . The **W map** is the natural transformation W

with components $W_A : !A \otimes A \rightarrow !A \otimes A$ defined as:

$$W_A = (d_A^\circ \otimes 1_A)(1_{!A} \otimes \sigma)(d_A \otimes 1_A)$$

In string diagram notation, the W -map is written out as follows:

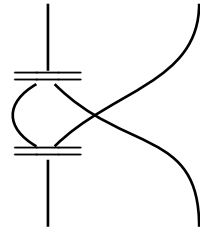

The main application of the W -map will be in the proof that the integral transformation that we will construct in Definition 6.19 satisfies the Poincaré condition. We will also use the W -map in certain other proofs in the following section, due in large part to the following property of the W -map.

Proposition 6.6. *The following equality holds for each object $A \in \text{Ob}(\mathbb{X})$:*

$$d_A d_A^\circ = W_A + 1_{!A \otimes A}$$

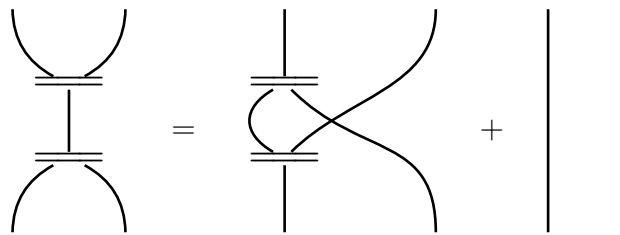

Proof. Here we use the Leibniz rule [d.2], that the derivative of a linear map is a constant

[d.3] and the counit of the comultiplication:

□

6.2 The L, K and J Maps

In this section we introduce the L, K and J Maps, which are natural transformation occurring in differential categories which are constructed using the deriving and coderiving transformations. The main purpose of the L Map will be to simplify proofs of the properties for the K and J maps. The properties of the K and J maps will often follow from the properties of the L map. In fact, some of the properties of the K and J maps are almost identical to those of the L map. We begin with the definition and give the string diagram notation, then give examples of the L, K and J maps in both of our main examples of calculus categories. We then provide many properties of these maps in Proposition 6.10, Proposition 6.11 and Proposition 6.12 respectively. The properties of the K and J maps will be used to establish properties of K^{-1} and J^{-1} .

Definition 6.7. Let $(\mathbb{X}, \otimes, K, \lambda, \rho, \sigma)$ be a differential category with coalgebra modality $(!, \delta, \varepsilon, \Delta, e)$ and deriving transformation d .

(i) The **L Map** is the natural transformation L with components $L_A : !A \rightarrow !A$ defined as:

$$L_A = d_A^\circ d_A$$

(ii) The **K Map** is the natural transformation K with components $K_A : !A \rightarrow !A$ defined

as:

$$K_A = L_A + !0 = d_A^\circ d_A + !0$$

where $0 : A \rightarrow A$.

(iii) The **J Map** is the natural transformation J with components $J_A : !A \rightarrow !A$ defined as:

$$J_A = L_A + 1_{!A} = d_A^\circ d_A + 1_{!A}$$

In string diagram notation, L , K and J are written out as follows:

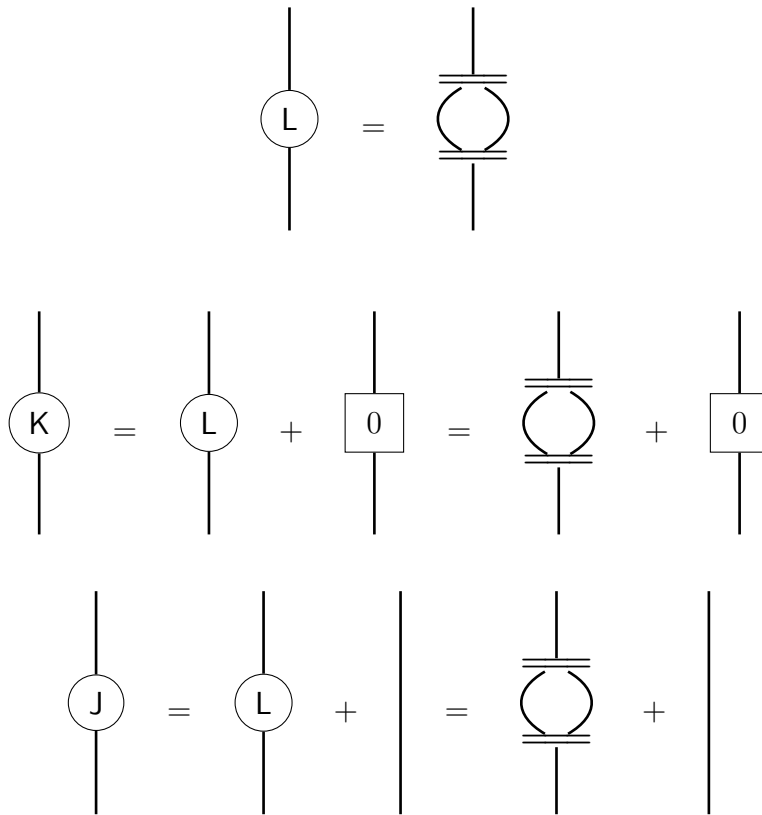

Before giving some properties of L , K and J , we give explicit descriptions of them in our main examples of differential categories.

Example 6.8. In REL for the differential structure on the finite bag coalgebra modality (see Example 4.9), the L map is almost the identity in the sense that it is the identity everywhere

but for the empty bag. Explicitly, L relates non-empty bags to themselves but does not relate the empty bag to anything:

$$L_X = \{(B, B) \mid B \in !(X) - \{\emptyset\}\} \subseteq !(X) \times !(X)$$

The K and J maps are equal to each other and equal to the identity! To see this, recall that our additive structure is given by the union of sets and the empty set (see Example 2.3). For K , recall that $!(\emptyset) = !(X) \rightarrow !(X)$ is the singleton of the empty bag pair $\{([\] , [\])\}$ (see Example 5.2), then we get the following equality:

$$K_X = L_X \cup \{([\] , [\])\} = \{(B, B) \mid B \in !(X)\} = 1_{!(X)}$$

For J , notice that $L_X \subsetneq 1_{!(X)}$ and so we get the following equality:

$$J_X = L_X \cup 1_{!(X)} = 1_{!(X)}$$

Example 6.9. In $\text{VEC}_{\mathbb{K}}$ for the differential structure on the free symmetric algebra modality (see Example 4.11), the L map gives the degree of each homogenous elements. On pure tensors, it is the scalar multiplication of a word by its length:

$$L_V(v_1 \otimes \dots \otimes v_n) = n \cdot (v_1 \otimes \dots \otimes v_n)$$

If this seems backwards, recall that $\text{VEC}_{\mathbb{K}}^{\text{Op}}$ is the differential and integral category. The K map is equal to the L map except on constants (elements of \mathbb{K}). The L map on constants is zero while the K map on constants is the identity since recall $!(0)$ is zero everywhere but for

constants (see Example 5.3):

$$\mathbf{K}_V(w) = \begin{cases} w & \text{if } w \in \text{Sym}^0(V) = \mathbb{K} \\ \mathbf{L}(w) & \text{o.w.} \end{cases}$$

The \mathbf{J} map gives the degree plus one of each homogenous elements. Explicitly on pure tensors, it is the scalar multiplication of a word by its length plus one:

$$\mathbf{J}_V(v_1 \otimes \dots \otimes v_n) = (n + 1) \cdot (v_1 \otimes \dots \otimes v_n)$$

Notice that in this case, unlike the previous example, the \mathbf{J} map is not equal to the \mathbf{K} map!

We now give properties of the \mathbf{L} map, which we will use to prove properties of the \mathbf{K} and \mathbf{J} maps.

Proposition 6.10. *The \mathbf{L} – map satisfies the following properties (see Table 6.2 for string diagrams) for each object $A \in \text{Ob}(\mathbb{X})$:*

$$[\mathbf{L.1}] \quad \mathbf{L}_A!(0) = 0 = !(0)\mathbf{L}_A \quad (\text{where } 0 : A \rightarrow A);$$

$$[\mathbf{L.2}] \quad \mathbf{L}_A e_A = 0;$$

$$[\mathbf{L.3}] \quad \mathbf{L}_A \varepsilon_A = \varepsilon_A;$$

$$[\mathbf{L.4}] \quad \mathbf{L}_A \Delta_A = \Delta_A(\mathbf{L}_A \otimes 1_A) + \Delta_A(1_A \otimes \mathbf{L}_A);$$

$$[\mathbf{L.5}] \quad \mathbf{L}_A \delta_A = \delta_A \mathbf{d}_A^\circ(1_A \otimes \mathbf{L}_A) \mathbf{d}_A;$$

$$[\mathbf{L.6}] \quad \mathbf{d}_A \mathbf{L}_A = (\mathbf{L}_A \otimes 1_A) \mathbf{d}_A + \mathbf{d}_A;$$

$$[\mathbf{L.7}] \quad \mathbf{L}_A \mathbf{d}_A^\circ = \mathbf{d}_A^\circ(\mathbf{L}_A \otimes 1_A) + \mathbf{d}_A^\circ;$$

$$[\mathbf{L.8}] \quad (\mathbf{d}_A^\circ \otimes 1_A)(\mathbf{L}_A \otimes 1_A) \mathbf{d}_A = (1_A \otimes \sigma_{A,A})(\mathbf{d}_A^\circ \otimes 1_A)(\mathbf{L}_A \otimes 1_A) \mathbf{d}_A;$$

$$[\mathbf{L.9}] \quad \mathbf{d}_A^\circ(\mathbf{L}_A \otimes 1_A)(\mathbf{d}_A^\circ \otimes 1_A) = \mathbf{d}_A^\circ(\mathbf{L}_A \otimes 1_A)(\mathbf{d}_A^\circ \otimes 1_A)(1_A \otimes \sigma_{A,A});$$

[L.10] $(L_A \otimes 1_A)W_A = W_A(L_A \otimes 1_A)$;

[L.11] $(L_A \otimes 1_A)d_A d_A^\circ = d_A d_A^\circ(L_A \otimes 1_A)$

Proof. These are mostly straightforward calculations:

[L.1]: Here we use the naturality of the deriving transformation and coderiving transformation:

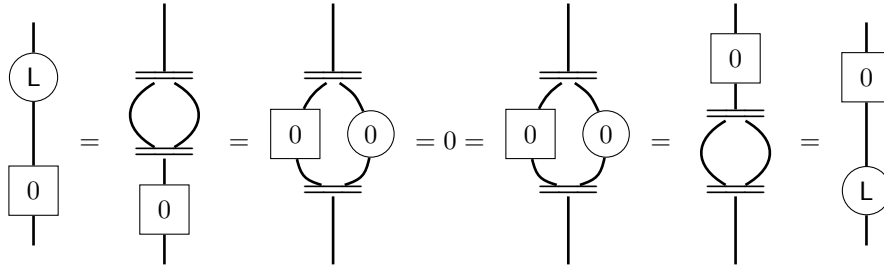

[L.2]: Here we use that the derivative of a constant is zero [d.1]:

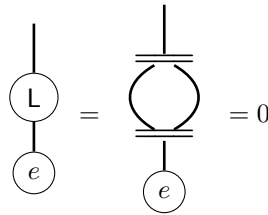

[L.3] Here we use that the derivative of a linear map is a constant [d.3] and [cd.1]:

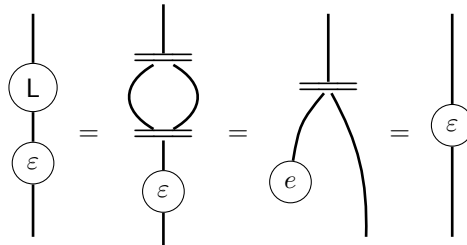

[L.4]: Here we use the Leibniz rule [d.2], [cd.3], [cd.4] and the cocommutativity of the

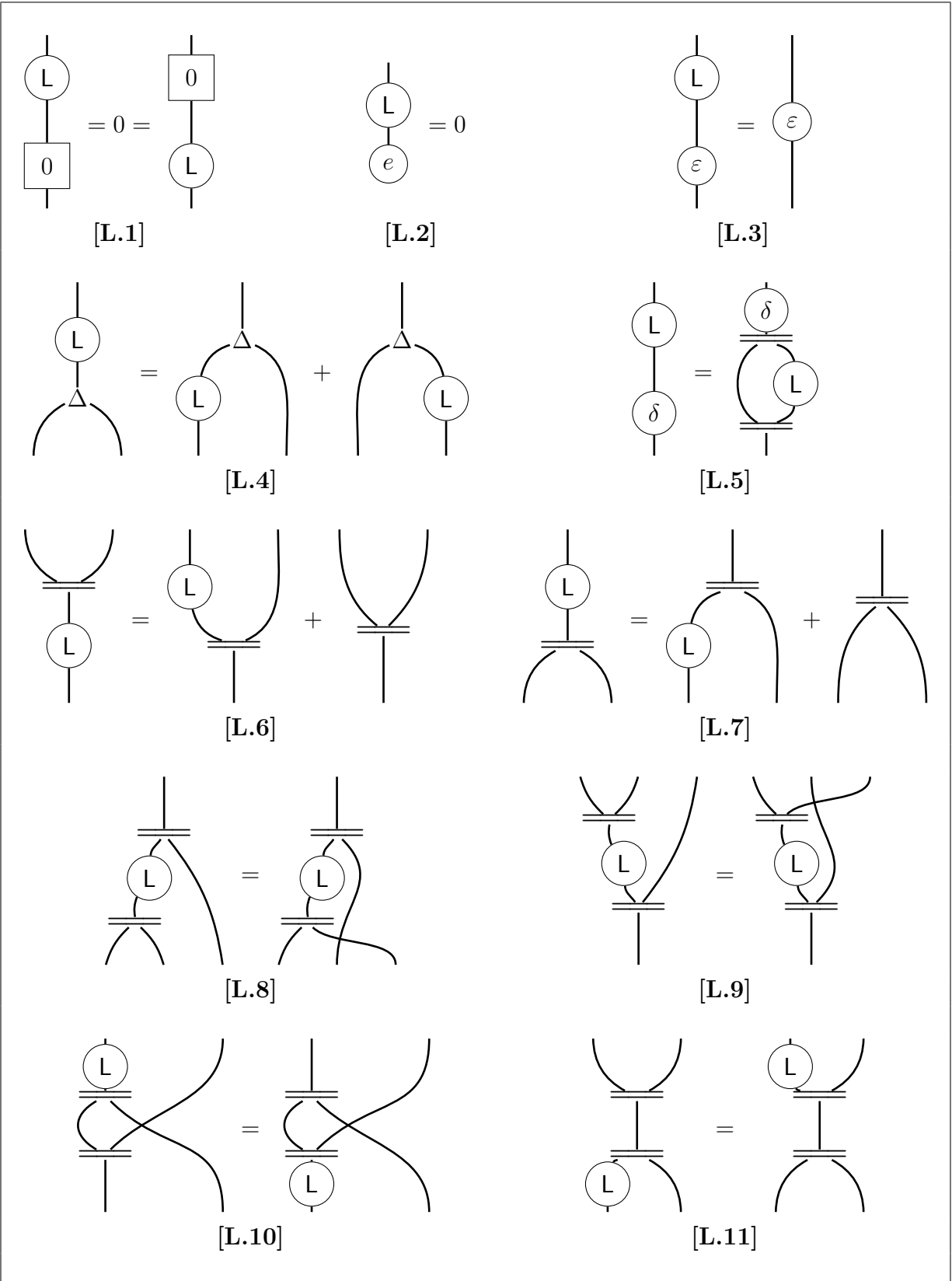
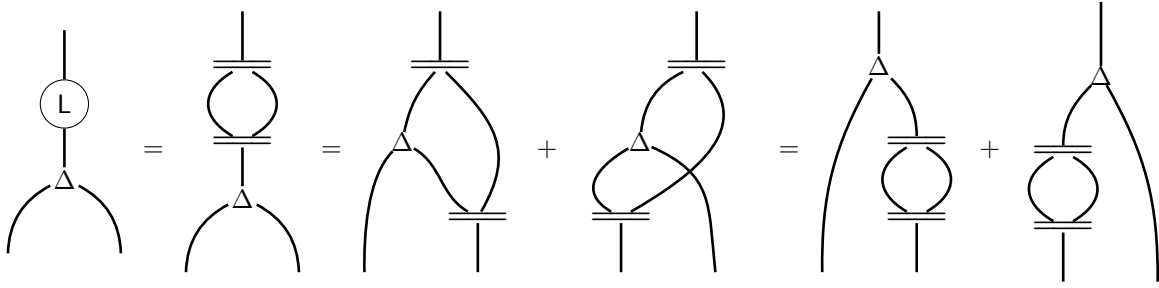
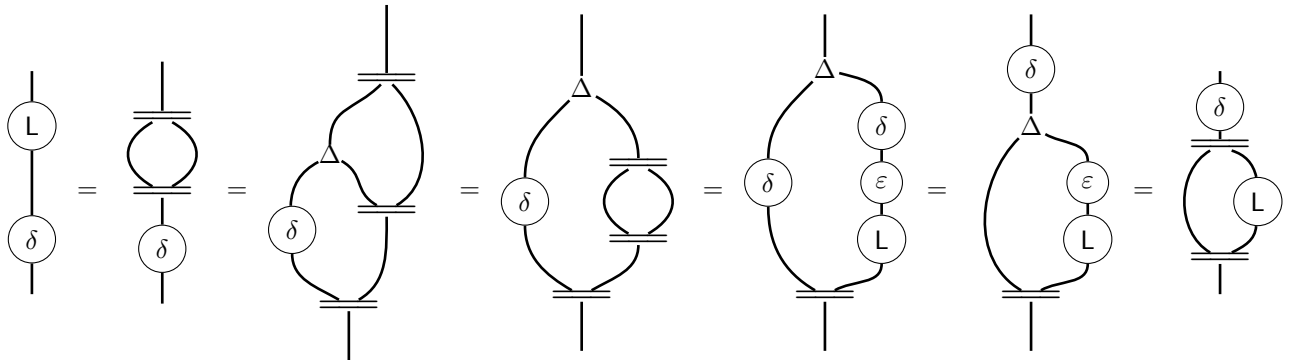

Table 6.2: Properties of L

comultiplication:



[L.5]: Here we use the chain rule [d.4], [cd.3], the comonad triangle identity and that δ is a coalgebra map:



[L.6]: Here we use Proposition 6.6 and [d.5]:

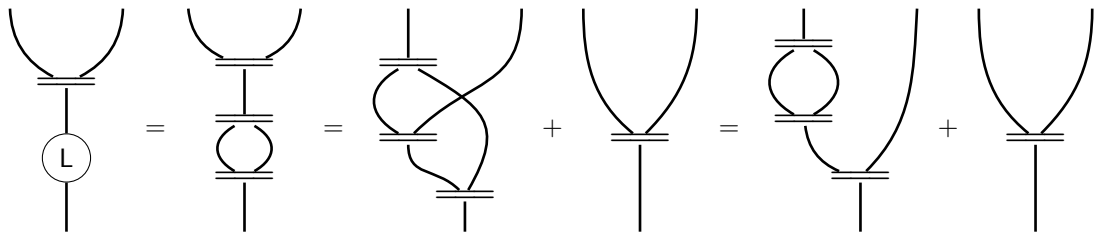

[L.7]: Here we use Proposition 6.6 and [cd.7]:

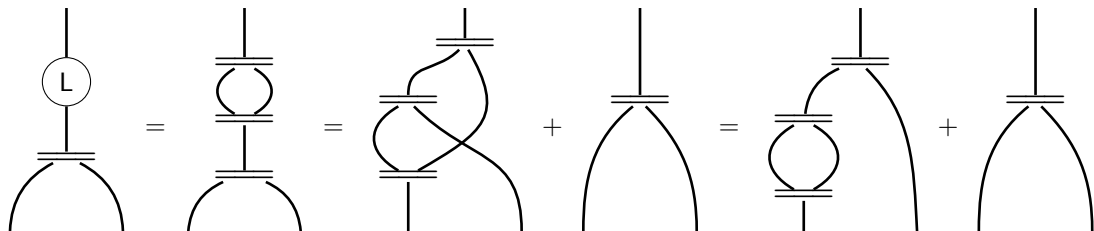

[L.8]: Here we use [L.6] and [cd.7]:

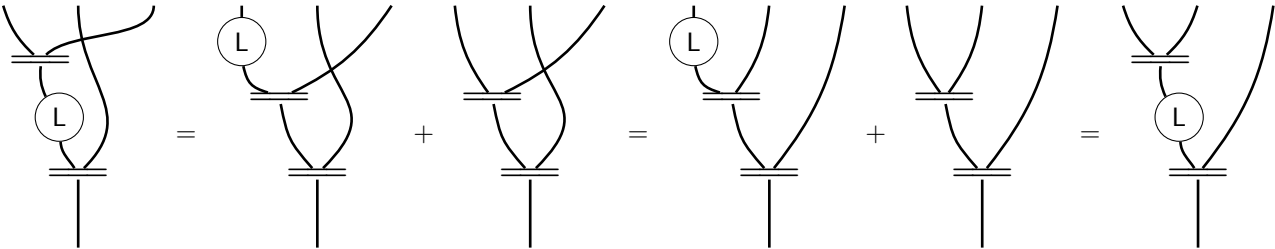

[L.9]: Here we use [L.7] and [d.5]:

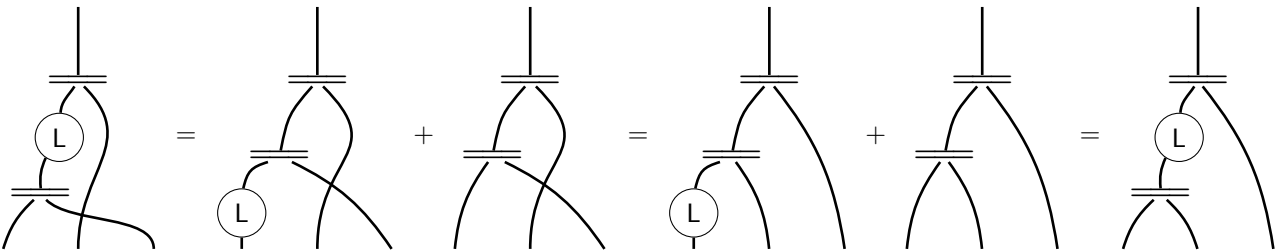

[L.10] Here we use [L.8] and [L.9]:

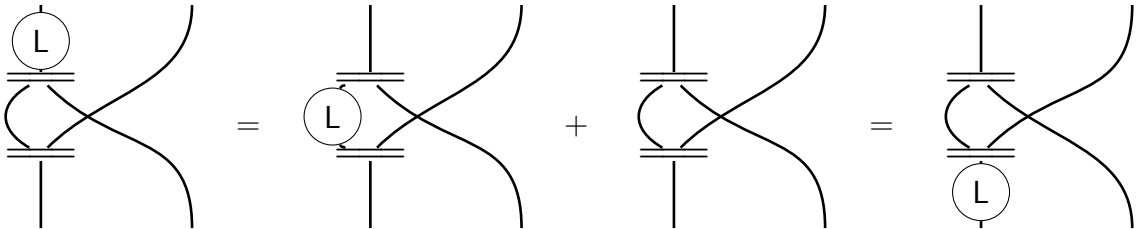

[L.11] Here we use [L.10]:

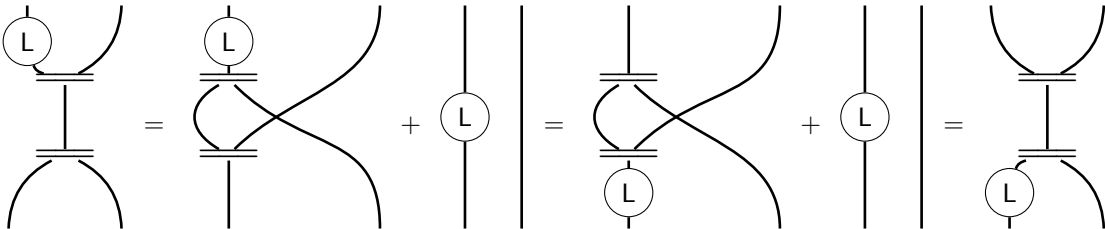

□

We now give properties of the K map, which we will use when constructing our integral transformation in a later section. Notice that most of the following properties of the K map

are extremely similar, sometimes identical, to the analogue properties for the L map.

Proposition 6.11. *The K map satisfies the following properties (see Table 6.3 for string diagrams) for each object $A \in \text{Ob}(\mathbb{X})$:*

[K.1] $K_A!(0) = !(0) = !(0)K_A$ (where $0 : A \rightarrow A$);

[K.2] $K_A e_A = e_A$;

[K.3] $K_A \varepsilon_A = \varepsilon_A$;

[K.4] $K_A \Delta_A = \Delta_A(L_A \otimes 1_A) + \Delta_A(1_A \otimes L_A) + \Delta_A(!(0) \otimes !(0))$;

[K.5] $K_A \delta_A = \delta_A d_{oc(A)}^\circ(1_{!(A)} \otimes L_A) d_A + \delta_A !(0)$;

[K.6] $d_A K_A = d_A L_A$;

[K.7] $K_A d_A^\circ = L_A d_A^\circ$;

[K.8] $(d_A^\circ \otimes 1_A)(K_A \otimes 1_A) d_A = (1_A \otimes \sigma_{A,A})(d_A^\circ \otimes 1_A)(K_A \otimes 1_A) d_A$;

[K.9] $d_A^\circ(K_A \otimes 1_A)(d_A^\circ \otimes 1_A) = d_A^\circ(K_A \otimes 1_A)(d_A^\circ \otimes 1_A)(1_A \otimes \sigma_{A,A})$;

[K.10] $(K_A \otimes 1_A)W_A = W_A(K_A \otimes 1_A)$;

[K.11] $(K_A \otimes 1_A)d_A d_A^\circ = d_A d_A^\circ(K_A \otimes 1_A)$.

Proof. These are mostly straightforward calculations using the properties of L :

[K.1]: Here we use [L.1] and that $!(0)!(0) = !(0)$:

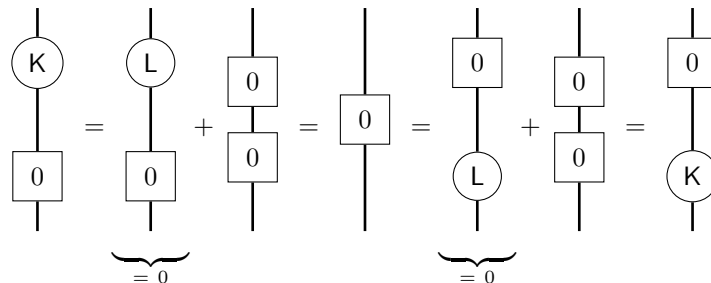

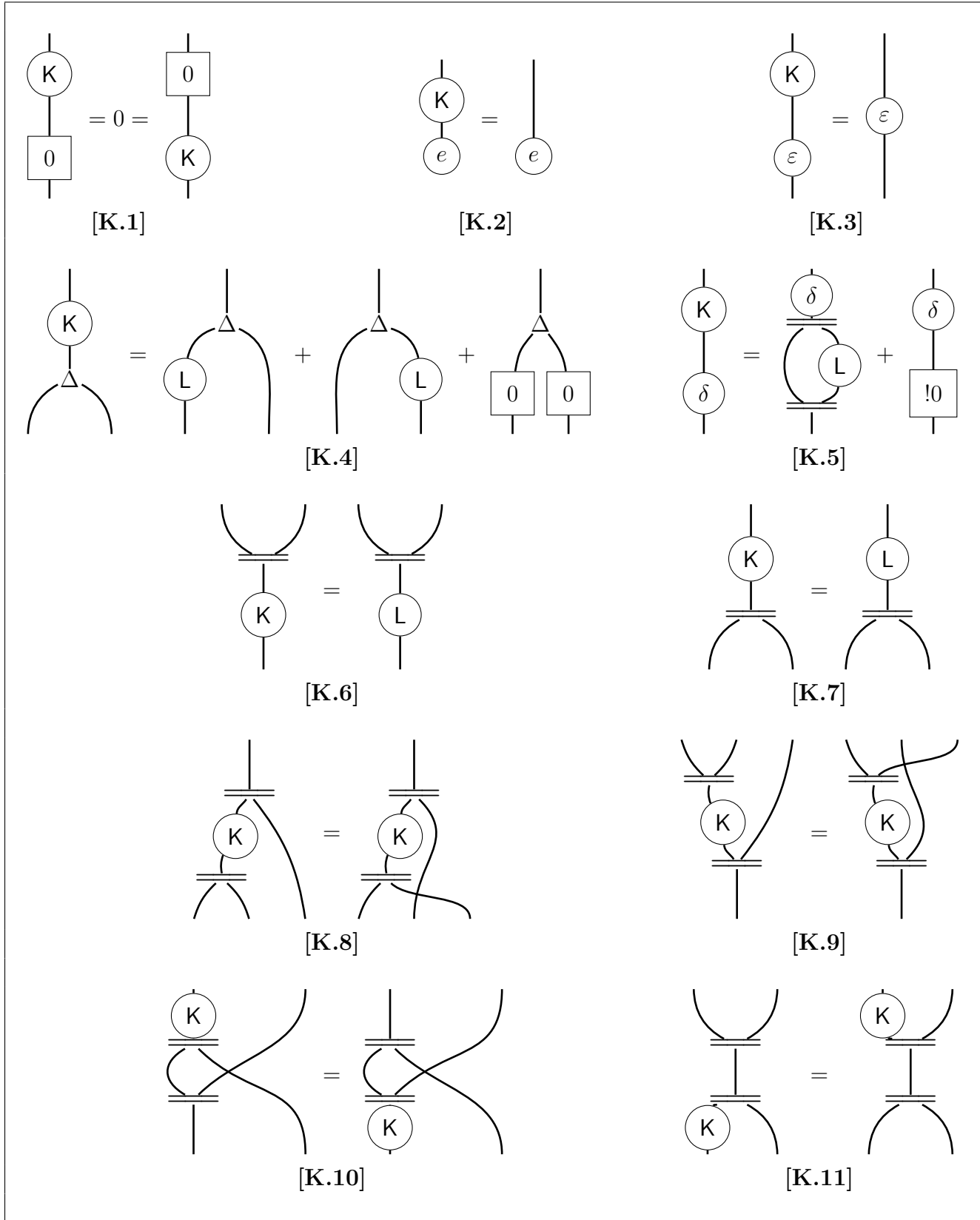
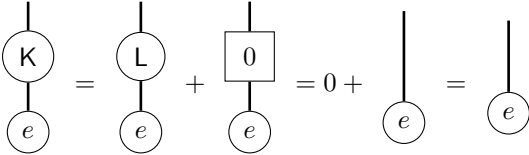
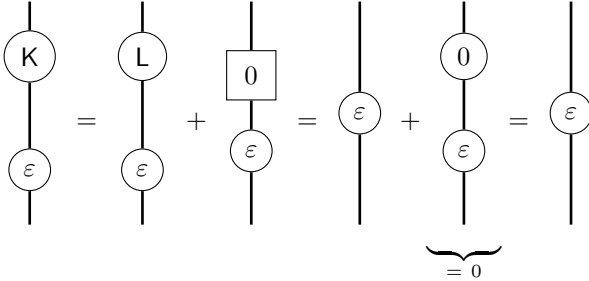

Table 6.3: Properties of K

[K.2]: Here we use [L.2] and the naturality of e :



[K.3]: Here we use [L.3] and the naturality of ε :



[K.4]: Here we use [L.4] and the naturality of Δ :

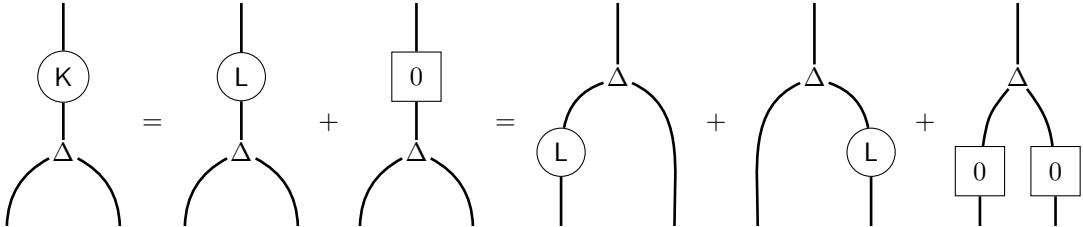

[K.5]: Here we use [L.5] and the naturality of δ :

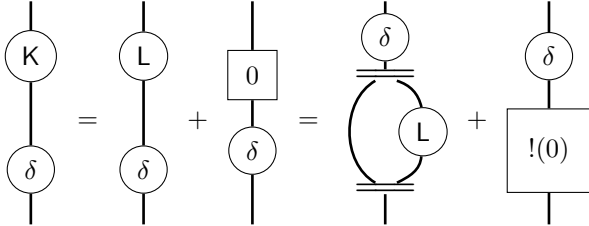

[K.6] Here we use the naturality of the differential transformation:

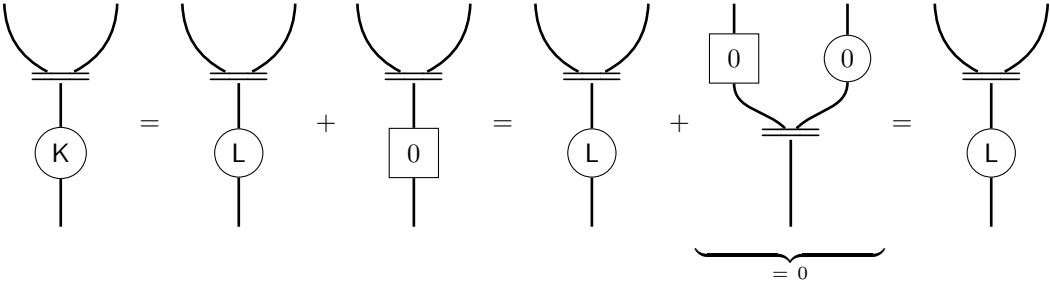

[K.7] Here we use the naturality of the coderivative:

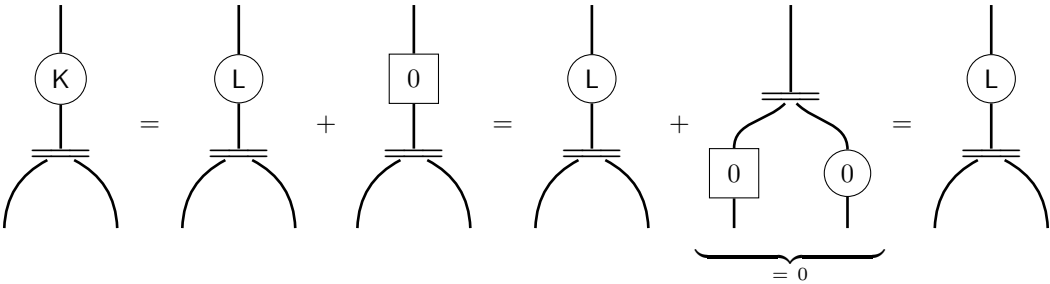

[K.8]: Here we use [K.6] and [L.8]:

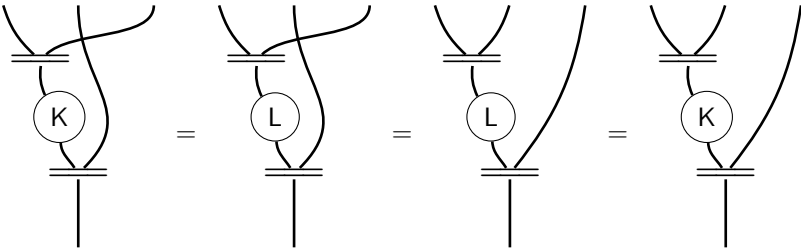

[K.9]: Here we use [K.7] and [L.9]:

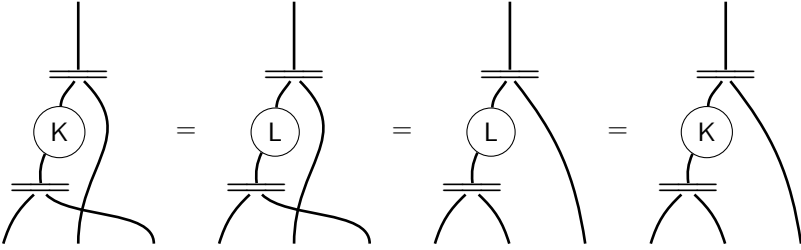

[K.10]: Here we use [K.6], [K.7] and [L.10]:

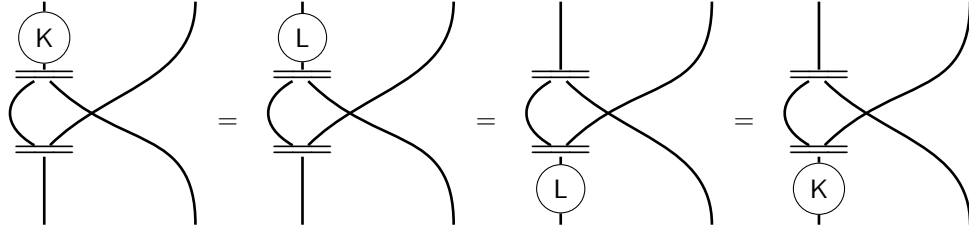

[K.11]: Here we use [K.10]:

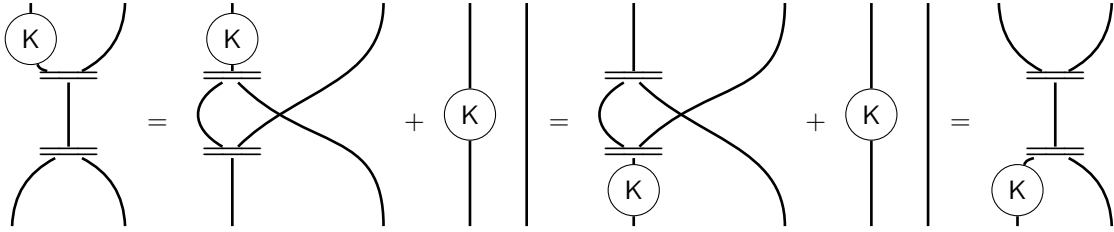

□

We now give properties of the J-map, which we will use when constructing our integral transformation in a later section. Similar to the K-map, most of the properties of the J-map are closely related to the properties of the L-map.

Proposition 6.12. *The J – map satisfies the following properties (see Table 6.4 and Table 6.5 for string diagrams) for each object $A \in \text{Ob}(\mathbb{X})$:*

$$[\mathbf{J.1}] \quad J_A ! (0) = ! (0) = ! (0) J_A;$$

$$[\mathbf{J.2}] \quad J_A e_A = e_A;$$

$$[\mathbf{J.3}] \quad J_A \varepsilon_A = 2 \cdot \varepsilon_A;$$

$$[\mathbf{J.4}] \quad J_A \Delta_A = \Delta_A (J_A \otimes 1_{!A}) + \Delta_A (1_{!A} \otimes L_A) = \Delta_A (L_A \otimes 1_{!A}) + \Delta_A (1_{!A} \otimes J_A) ;$$

$$[\mathbf{J.5}] \quad J_A \delta_A = \delta_A d_{!A}^\circ (1_{!(!A)} \otimes L_{!A}) d_{!A} + \delta_A;$$

$$[\mathbf{J.6}] \quad (J_A \otimes 1_A) d_A = d_A L_A = d_A K_A;$$

$$[\mathbf{J.7}] \quad d_A^\circ(J_A \otimes 1) = L_A d_A^\circ = K_A d_A^\circ;$$

$$[\mathbf{J.8}] \quad dJ = (J \otimes 1)d + d;$$

$$[\mathbf{J.9}] \quad Jd^\circ = d^\circ(J \otimes 1) + d^\circ;$$

$$[\mathbf{J.10}] \quad (d^\circ \otimes 1)(J \otimes 1)d = (1 \otimes \sigma)(d^\circ \otimes 1)(J \otimes 1)d;$$

$$[\mathbf{J.11}] \quad d^\circ(J \otimes 1)(d^\circ \otimes 1) = d^\circ(J \otimes 1)(d^\circ \otimes 1)(1 \otimes \sigma);$$

$$[\mathbf{J.12}] \quad (J_A \otimes 1_A)W_A = W_A(J_A \otimes 1_A);$$

$$[\mathbf{J.13}] \quad (J_A \otimes 1_A)d_A d_A^\circ = d_A d_A^\circ(J_A \otimes 1_A).$$

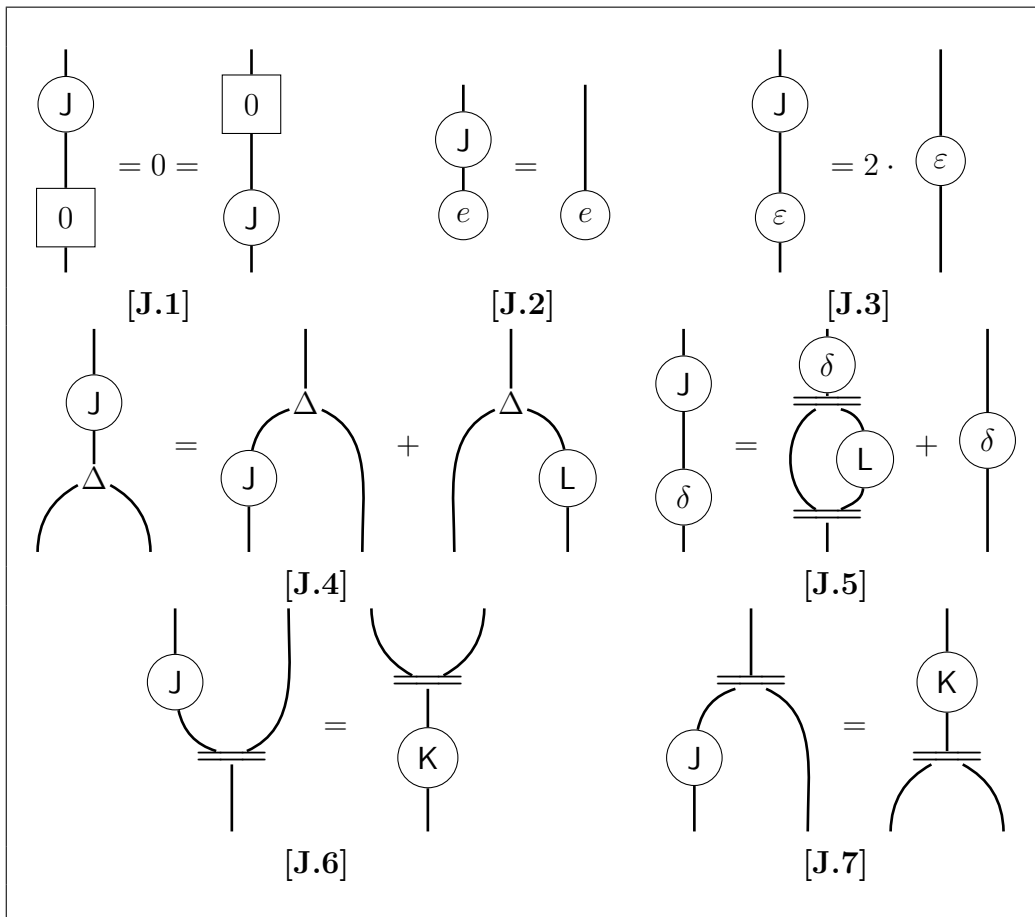

Table 6.4: Properties of J, Part 1

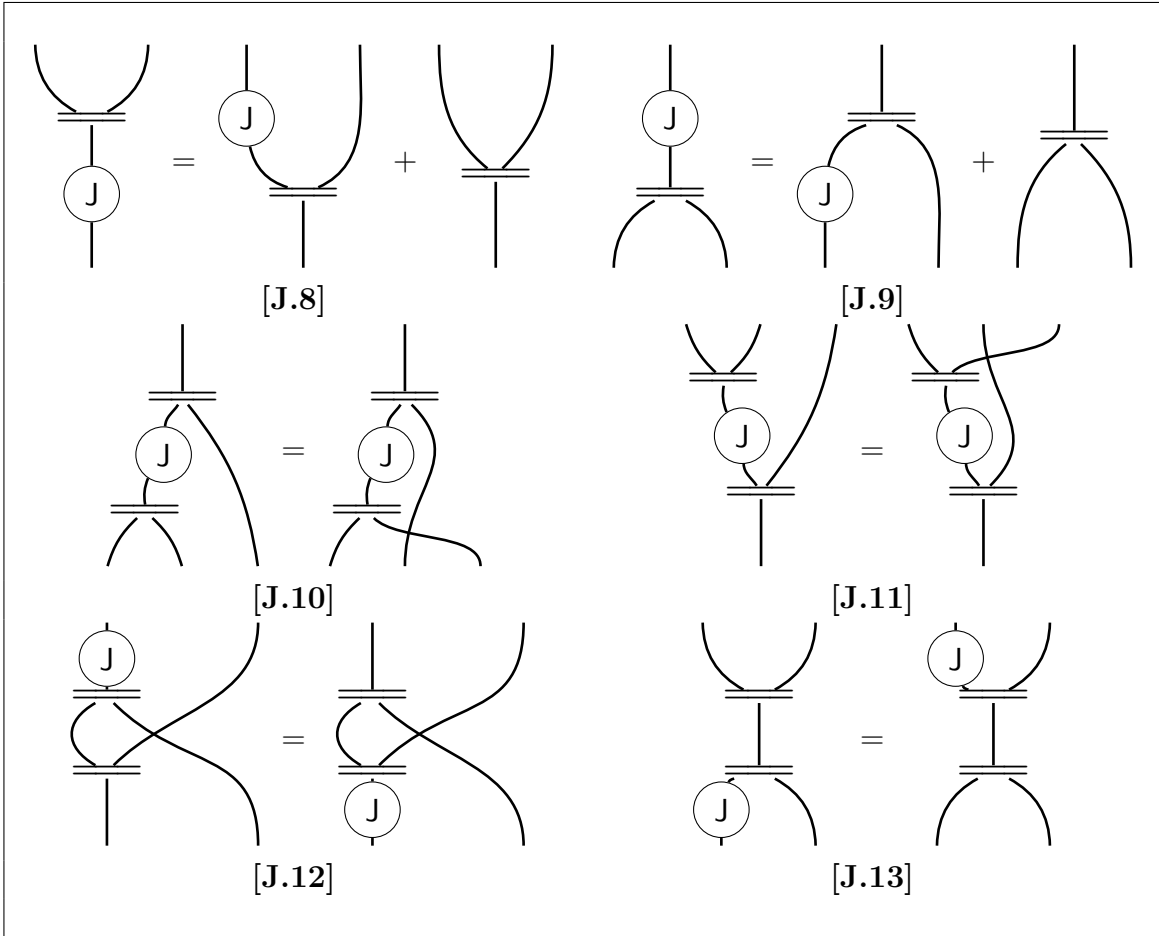
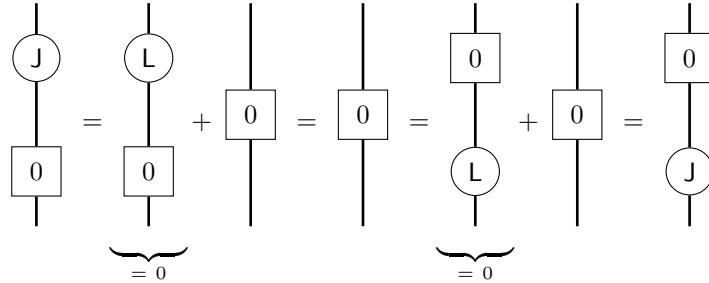

Table 6.5: Properties of J, Part 2

Proof. These are mostly straightforward calculations using the properties of **L**:

[J.1]: Here we use [L.1]:



[J.2]: Here we use [L.2]:

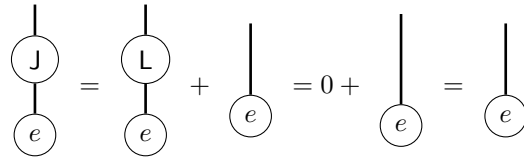

[J.3]: Here we use [L.3]:

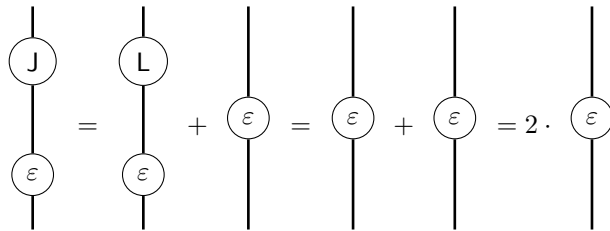

[J.4]: Here we use [L.4] and the naturality of Δ :

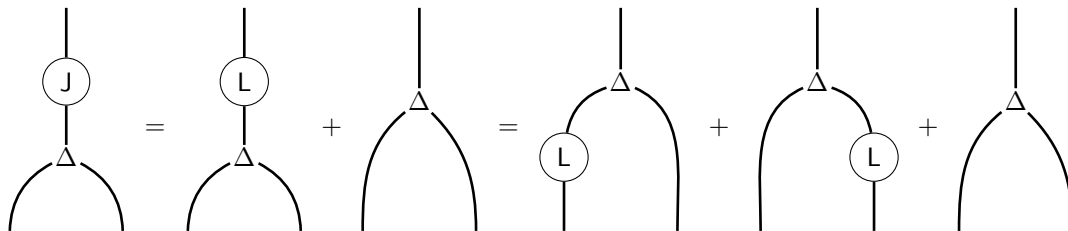

$$= \text{Diagram 1} + \text{Diagram 2} = \text{Diagram 3} + \text{Diagram 4}$$

The first diagram shows a vertical line entering from the bottom, passing through a circle labeled 'J', then curving upwards to meet a triangle at the top. The second diagram is similar but with a circle labeled 'L' instead of 'J'. The third diagram has a circle labeled 'L' on the left side of the curve. The fourth diagram has a circle labeled 'J' on the right side of the curve.

[J.5]: Here we use [L.5]:

$$\text{Diagram 1} = \text{Diagram 2} + \text{Diagram 3} = \text{Diagram 4} + \text{Diagram 5}$$

Diagram 1: A vertical line with a circle 'J' on top and a circle 'δ' on bottom.
 Diagram 2: A vertical line with a circle 'L' on top and a circle 'δ' on bottom.
 Diagram 3: A vertical line with a circle 'δ' in the middle.
 Diagram 4: A vertical line with a circle 'δ' on top, a circle 'L' on the right side of a loop, and a circle 'δ' on bottom.
 Diagram 5: A vertical line with a circle 'δ' on bottom.

[J.6]: Here we use [L.6]:

$$\text{Diagram 1} = \text{Diagram 2} + \text{Diagram 3} = \text{Diagram 4} = \text{Diagram 5}$$

Diagram 1: A U-shaped curve with a circle 'J' on the left side and a double horizontal line at the bottom.
 Diagram 2: A U-shaped curve with a circle 'L' on the left side and a double horizontal line at the bottom.
 Diagram 3: A U-shaped curve with a double horizontal line at the bottom.
 Diagram 4: A U-shaped curve with a circle 'L' in the middle and a double horizontal line at the bottom.
 Diagram 5: A U-shaped curve with a circle 'K' in the middle and a double horizontal line at the bottom.

[J.7]: Here we use [L.7]:

$$\text{Diagram 1} = \text{Diagram 2} + \text{Diagram 3} = \text{Diagram 4} = \text{Diagram 5}$$

Diagram 1: A U-shaped curve with a circle 'J' on the left side and a double horizontal line at the top.
 Diagram 2: A U-shaped curve with a circle 'L' on the left side and a double horizontal line at the top.
 Diagram 3: A U-shaped curve with a double horizontal line at the top.
 Diagram 4: A vertical line with a circle 'L' in the middle and a double horizontal line at the bottom.
 Diagram 5: A vertical line with a circle 'K' in the middle and a double horizontal line at the bottom.

[J.8]: Here we use [L.6]:

$$\text{Diagram 1} = \text{Diagram 2} + \text{Diagram 3} = \text{Diagram 4} + 2 \cdot \text{Diagram 5} = \text{Diagram 6} + \text{Diagram 7}$$

Diagram 1: A U-shaped curve with a double horizontal line at the bottom and a circle 'J' in the middle.
 Diagram 2: A U-shaped curve with a double horizontal line at the bottom and a circle 'L' in the middle.
 Diagram 3: A U-shaped curve with a double horizontal line at the bottom.
 Diagram 4: A U-shaped curve with a circle 'L' on the left side and a double horizontal line at the bottom.
 Diagram 5: A U-shaped curve with a double horizontal line at the bottom.
 Diagram 6: A U-shaped curve with a circle 'J' on the left side and a double horizontal line at the bottom.
 Diagram 7: A U-shaped curve with a double horizontal line at the bottom.

[J.9]: Here we use [L.7]:

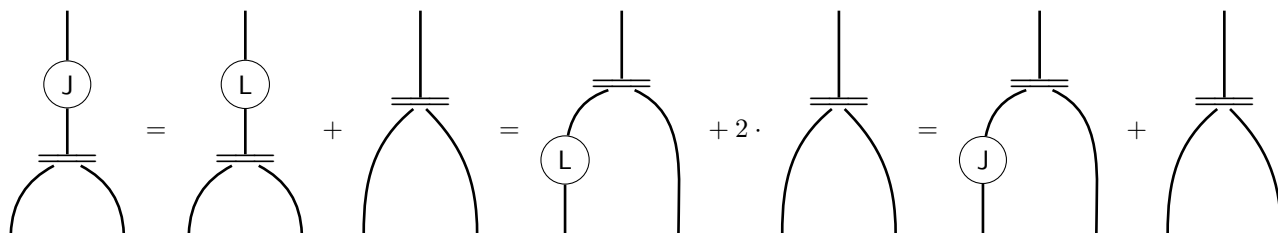

[J.10]: Here we use [J.6] and [d.5]:

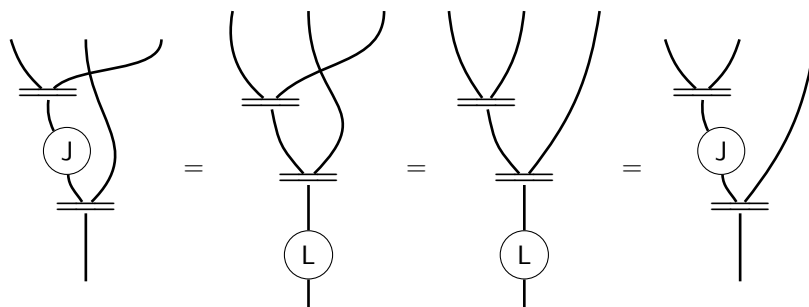

[J.11]: Here we use [J.7] and [cd.7]:

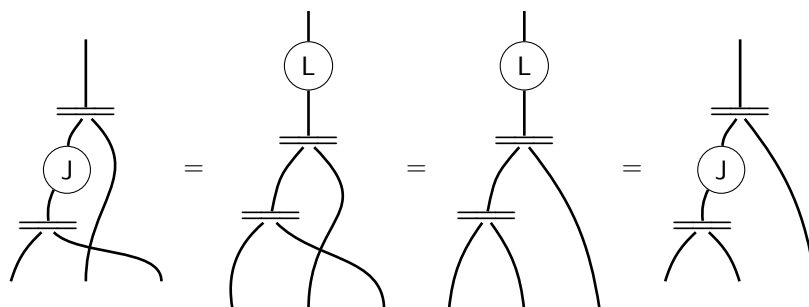

[J.12]: Here we use [L.10]:

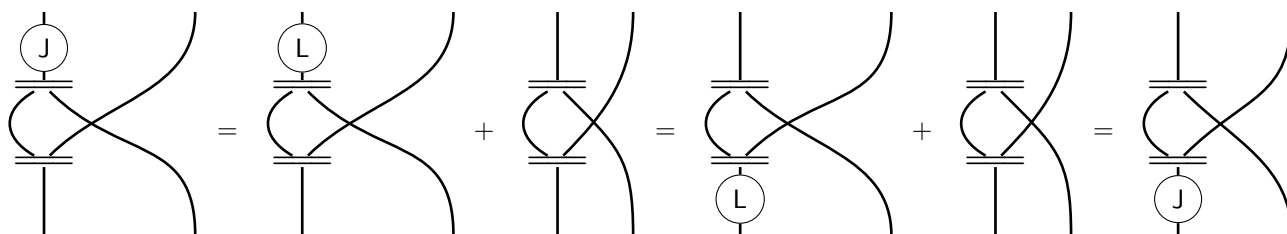

[J.13]: Here we use [J.12]:

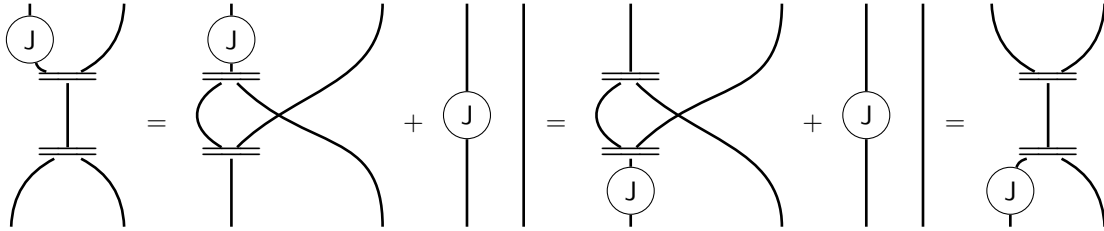

□

6.3 Antiderivatives: the K^{-1} and J^{-1} Maps

In this section we explain what it means for a differential category to have antiderivatives. This simply means that the K -map is a natural isomorphism. However in Proposition 6.13, we will see that K being invertible is equivalent to J being invertible and the Taylor Property. We begin this section by proving this equivalence then provide properties of K^{-1} and J^{-1} in Proposition 6.17 and Proposition 6.18 respectively. We will use these properties when proving the integral transformation axioms, the Second Fundamental Theorem of Calculus and the Poincaré Condition.

To say that the K -map is a natural isomorphism means that there exists a natural transformation K^{-1} with components $K_A^{-1} : !A \rightarrow !A$ such that for each object $A \in Ob(\mathbb{X})$: $K_A K_A^{-1} = 1_{!A} = K_A^{-1} K_A$. A similar statement can be said for the J -map to be a natural isomorphism. In string diagram notation, the isomorphism property of the K and J maps are written out in the following obvious way:

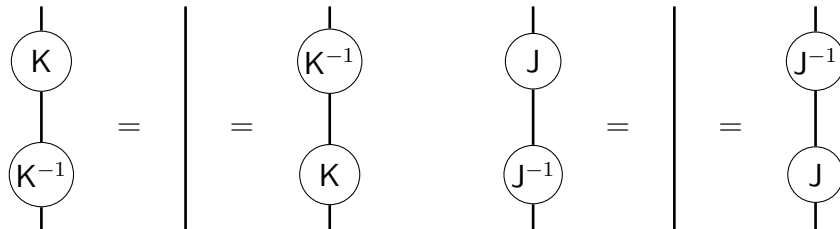

In the following proposition we show that K being a natural isomorphism is equivalent to J being a natural isomorphism with an added assumption.

Proposition 6.13. *In a differential category, the following are equivalent:*

- (i) K is a natural isomorphism;
- (ii) J is a natural isomorphism and the deriving transformation is Taylor (see Definition 5.5).

Proof. (i) \Rightarrow (ii): Suppose that K is a natural isomorphism. Define the components of J^{-1} as follows:

$$J_A^{-1} = \delta_A K_{!A}^{-1} d_{!A}^{\circ} (!(\varepsilon_A) \otimes e_A) \rho_{!A}$$

In string diagrams, J^{-1} is written out as follows:

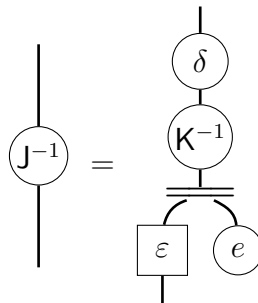

We need to prove that $JJ^{-1} = 1$, $J^{-1}J = 1$ and that the deriving transformation is Taylor. We begin by proving that $J^{-1}J = 1$. Here we use naturality of J , [J.7], that δ is a comonoid morphism and the counit laws for the comultiplication.

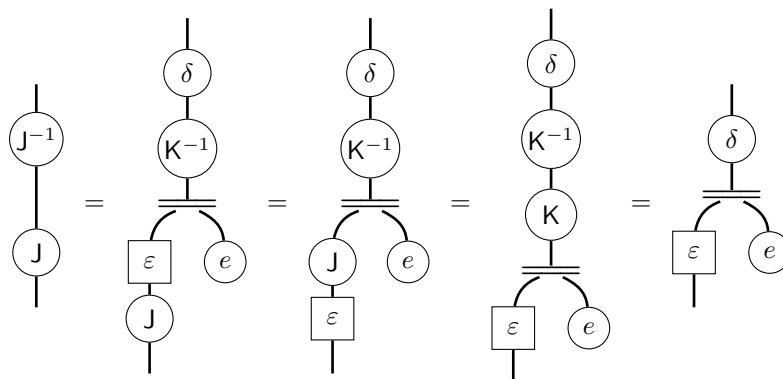

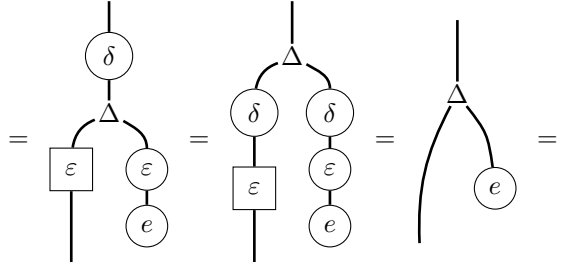

Next we show that $JJ^{-1} = 1$. Here we use [J.5], [J.6], [J.7], naturality of the coderiving and deriving transformations, [cd.7], [L.2], [L.3], Proposition 6.6 and that we already proven $J^{-1}J = 1$.

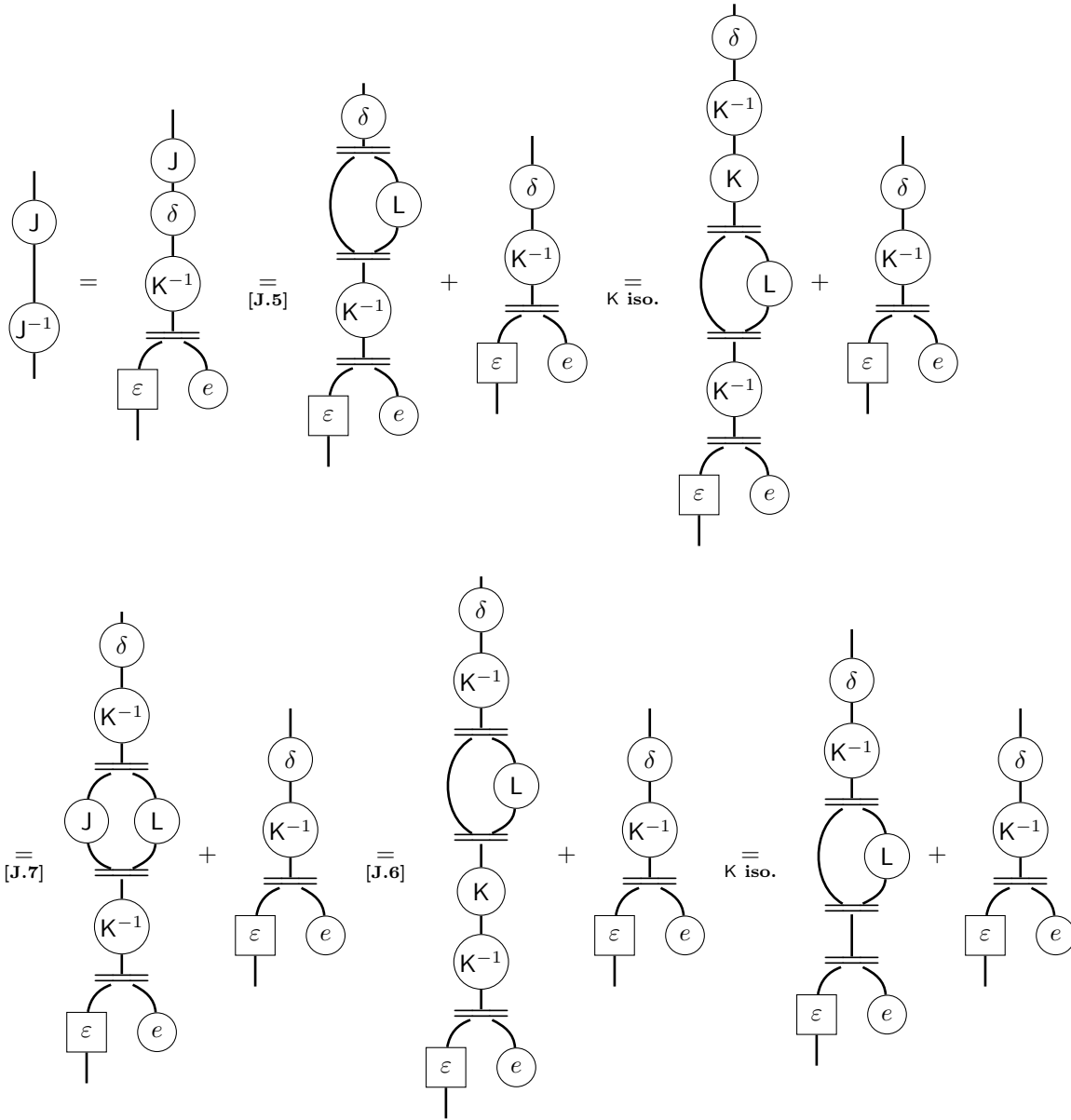

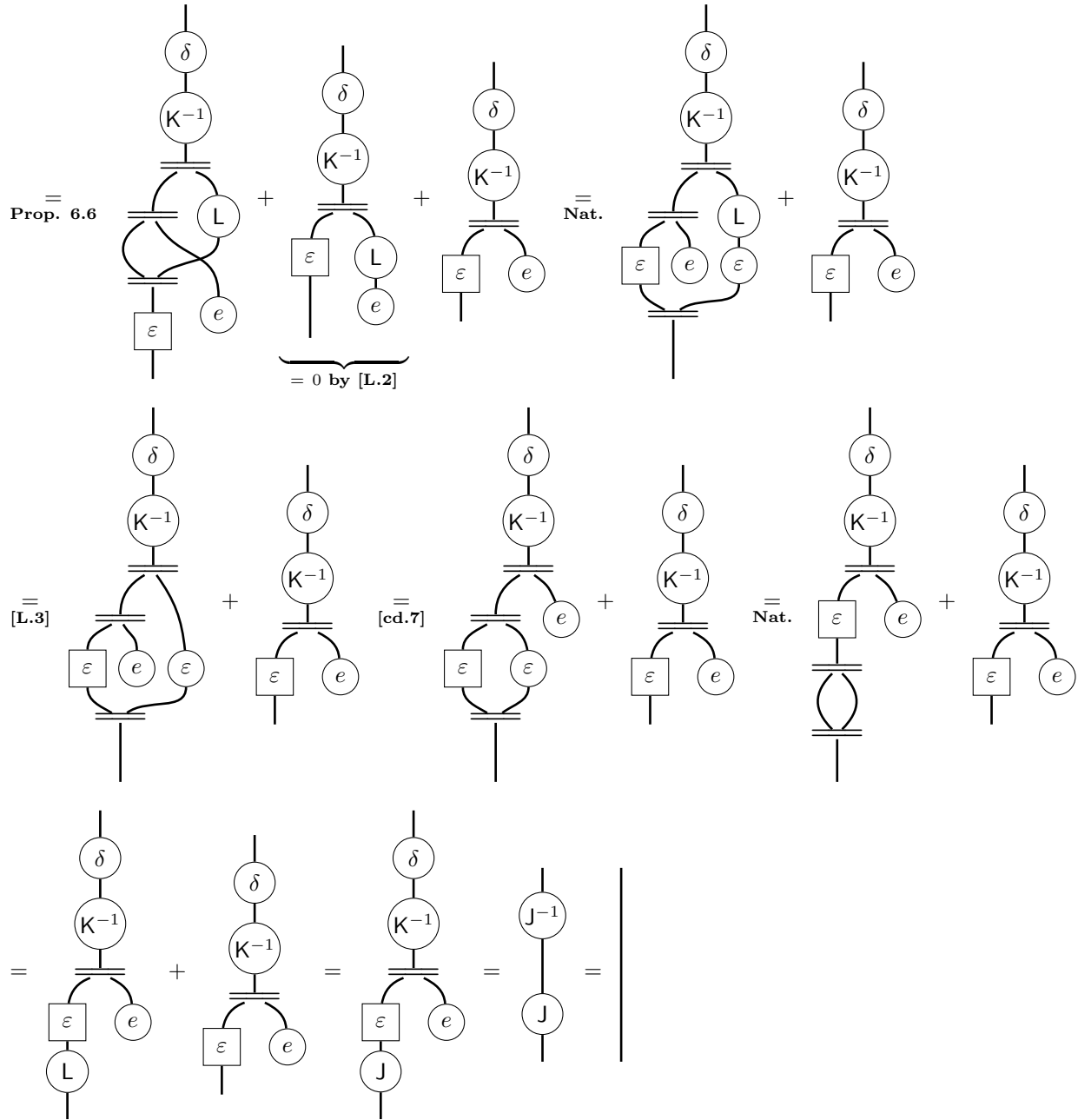

Finally, we need to show that the deriving transformation is Taylor. We will delay the proof to the following section in Proposition 6.21. Indeed, we will prove a stronger statement! When K is a natural isomorphism we can construct an integral transformation which will satisfy the Second Fundamental Theorem of Calculus when paired with the deriving transformation. By Proposition 5.6, the deriving transformation is then Taylor.

(ii) \Rightarrow (i): Suppose that J is a natural isomorphism and the deriving transformation is Taylor. Define K^{-1} component wise as follows:

$$K_A^{-1} = d_A^{\circ}(J_A^{-1} \otimes 1_A)(J_A^{-1} \otimes 1_A)d_A + !0$$

where $0 : A \rightarrow A$. In string diagrams, K^{-1} is written out as follows:

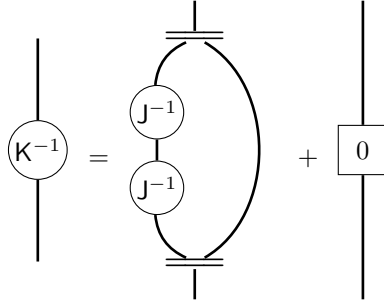

We need to prove that $KK^{-1} = 1$ and $K^{-1}K = 1$. First we have the following equality by [K.1], [J.6] and [J.7]:

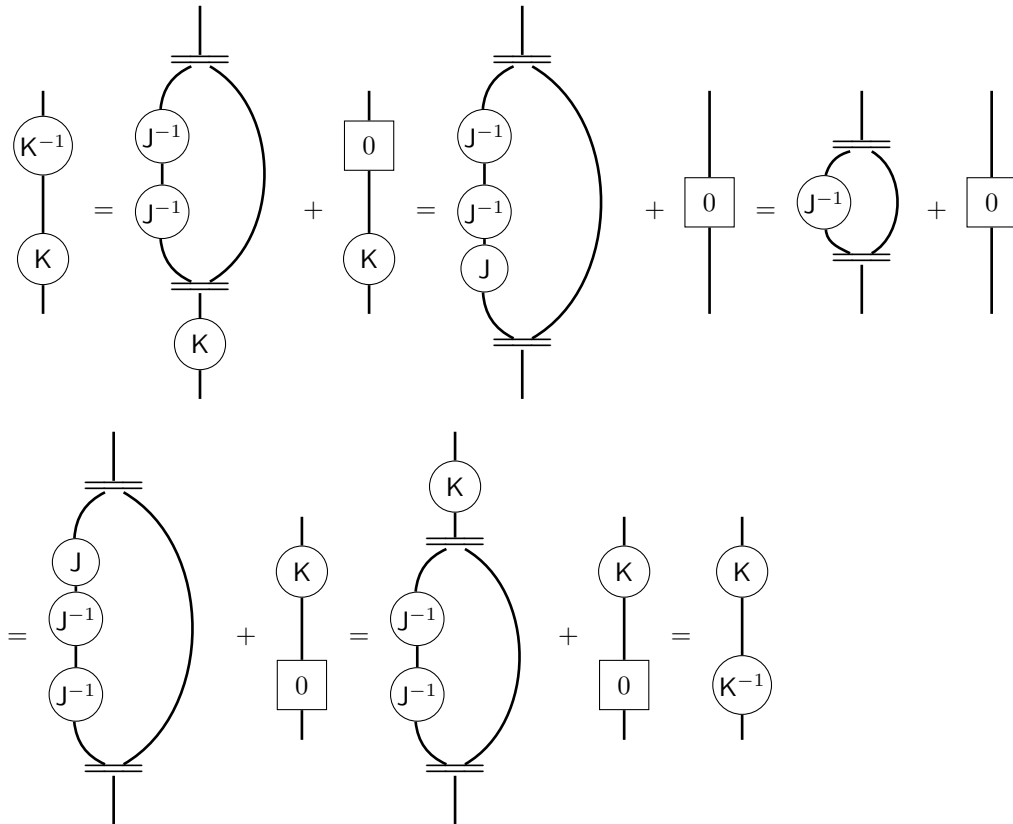

Therefore, $KK^{-1} = K^{-1}K = d^\circ(J^{-1} \otimes 1)d + !0$. Consider now the derivative of $d^\circ(J^{-1} \otimes 1)d$:

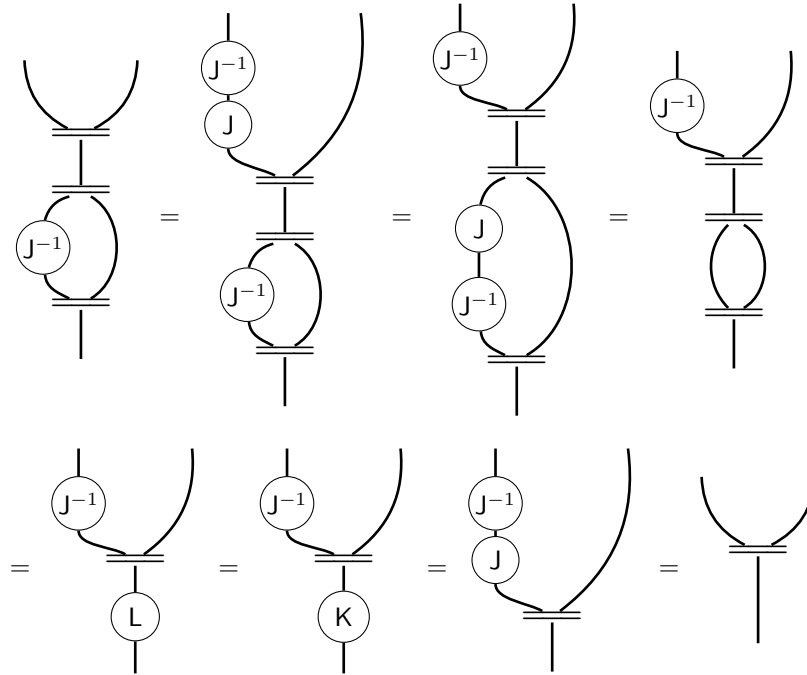

Then $dd^\circ(J^{-1} \otimes 1)d = d$. Since the deriving transformation is Taylor, we have the following equality:

$$d^\circ(J^{-1} \otimes 1)d + !0 = 1 + !0d^\circ(J^{-1} \otimes 1)d$$

However by naturality we have that $!0d^\circ(J^{-1} \otimes 1)d = d^\circ(!0 \otimes 0)(J^{-1} \otimes 1)d = 0$. Finally, we conclude:

$$KK^{-1} = K^{-1}K = d^\circ(J^{-1} \otimes 1)d + !0 = 1$$

□

Definition 6.14. A differential category is said to have **antiderivatives** if the K -map is a natural isomorphism (or equivalently, if J is a natural isomorphism and the deriving transformation is Taylor).

Before giving some properties of the K^{-1} and J^{-1} maps, we give explicit descriptions of K^{-1} and J^{-1} in our main examples.

Example 6.15. In REL with the differential structure on the finite bag coalgebra modality (see Example 4.9 for structure), since the \mathbf{K} and \mathbf{J} maps are the identity, they are trivially isomorphisms. Explicitly, REL has antiderivatives where the \mathbf{K}^{-1} and \mathbf{J}^{-1} maps are equal to the identity.

Example 6.16. In $\text{VEC}_{\mathbb{K}}$ with the differential structure on the free symmetric algebra modality (see Example 4.11 for structure), both \mathbf{K} and \mathbf{J} are natural isomorphisms. Explicitly, $\text{VEC}_{\mathbb{K}}$ has antiderivatives where the \mathbf{K}^{-1} -map on pure tensors is given by the following scalar multiplication:

$$\mathbf{K}_V^{-1}(w) = \begin{cases} w & \text{if } w \in \text{Sym}^0(V) = \mathbb{K} \\ \frac{1}{n} \cdot (v_1 \otimes \dots \otimes v_n) & \text{if } w = v_1 \otimes \dots \otimes v_n \in \text{Sym}^n(V) \end{cases}$$

The \mathbf{J}^{-1} map on pure tensors is given as follows:

$$\mathbf{J}_V^{-1}(v_1 \otimes \dots \otimes v_n) = \frac{1}{n+1} \cdot (v_1 \otimes \dots \otimes v_n)$$

We now give properties of the \mathbf{K}^{-1} -map, which we will use to show that integral transformation that we will construct satisfies the integral axioms and the Second Fundamental Theorem of Calculus.

Proposition 6.17. *The \mathbf{K}^{-1} -map satisfies the following properties (see Table 6.6 for string diagrams) for each object $A \in \text{Ob}(\mathbb{X})$:*

$$[\mathbf{K}^{-1}.1] \quad \mathbf{K}_A^{-1}!(0) = !(0) = !(0)\mathbf{K}_A^{-1};$$

$$[\mathbf{K}^{-1}.2] \quad \mathbf{K}_A^{-1}e_A = e_A;$$

$$[\mathbf{K}^{-1}.3] \quad \mathbf{K}_A^{-1}\varepsilon_A = \varepsilon_A;$$

$$\begin{aligned} [\mathbf{K}^{-1}.4] \quad & \Delta_A(\mathbf{K}_A^{-1} \otimes \mathbf{K}_A^{-1}) + \Delta_A(\mathbf{K}_A^{-1} \otimes !(0)) + \Delta_A(!(0) \otimes \mathbf{K}_A^{-1}) \\ & = \mathbf{K}_A^{-1}\Delta_A(\mathbf{K}_A^{-1} \otimes 1_{!A}) + \mathbf{K}_A^{-1}\Delta_A(1_{!A} \otimes \mathbf{K}_A^{-1}) + \Delta_A(!(0) \otimes !(0)) \end{aligned}$$

$$[\mathbf{K}^{-1}.5] \quad (\mathbf{K}_A^{-1} \otimes 1_A)W_A = W_A(\mathbf{K}_A^{-1} \otimes 1_A);$$

$$[\mathbf{K}^{-1}.6] \quad (\mathbf{K}_A^{-1} \otimes 1_A)d_A d_A^\circ = d_A d_A^\circ (\mathbf{K}_A^{-1} \otimes 1_A);$$

$$[\mathbf{K}^{-1}.7] \quad (d_A \otimes 1_A)(\mathbf{K}_A^{-1} \otimes 1_A)d_A = (1_A \otimes \sigma_{A,A})(d_A \otimes 1_A)(\mathbf{K}_A^{-1} \otimes 1_A)d_A;$$

$$[\mathbf{K}^{-1}.8] \quad d_A^\circ (\mathbf{K}_A^{-1} \otimes 1_A)(d_A^\circ \otimes 1_A) = d_A^\circ (\mathbf{K}_A^{-1} \otimes 1_A)(d_A^\circ \otimes 1_A)(1_A \otimes \sigma_{A,A}).$$

Proof. These are mostly straightforward calculations by using the properties of \mathbf{K} and that \mathbf{K} is an isomorphism:

$[\mathbf{K}^{-1}.1]$: Here we use $[\mathbf{K}.1]$:

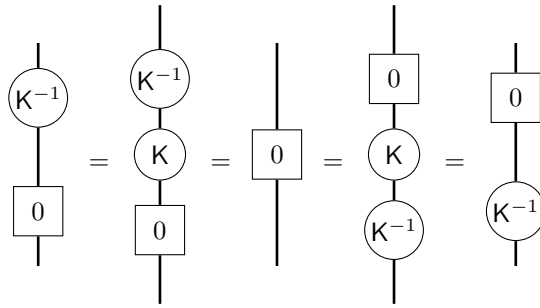

$[\mathbf{K}^{-1}.2]$: Here we use $[\mathbf{K}.2]$:

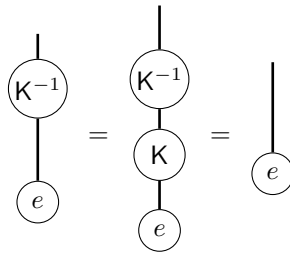

$[\mathbf{K}^{-1}.3]$: Here we use $[\mathbf{K}.3]$:

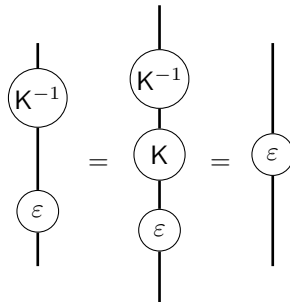

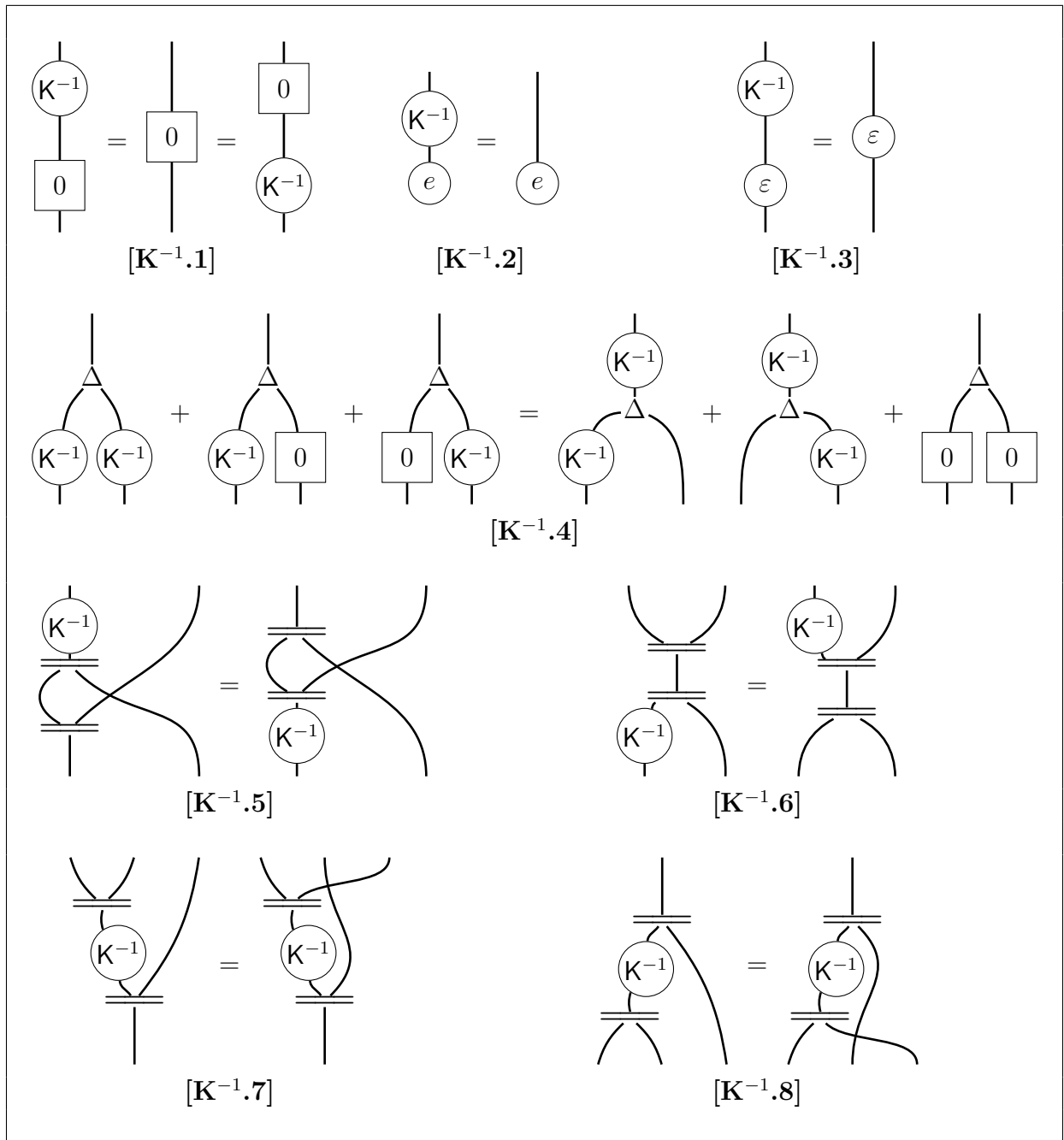
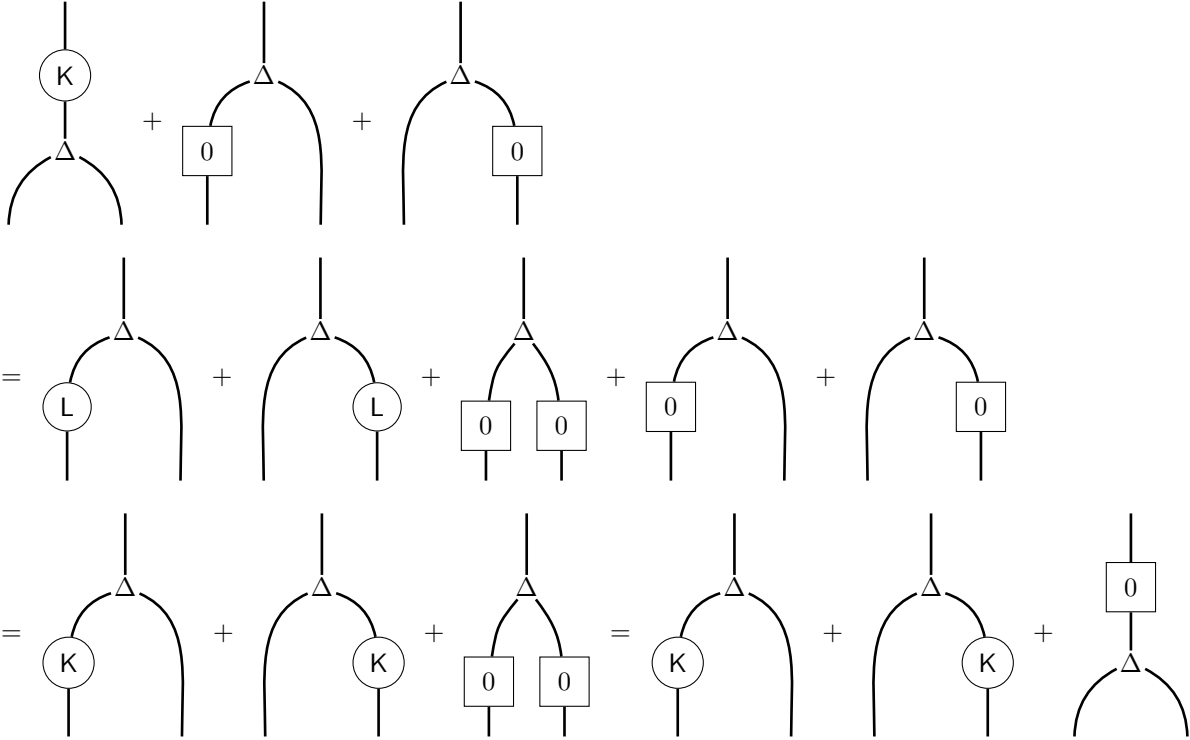
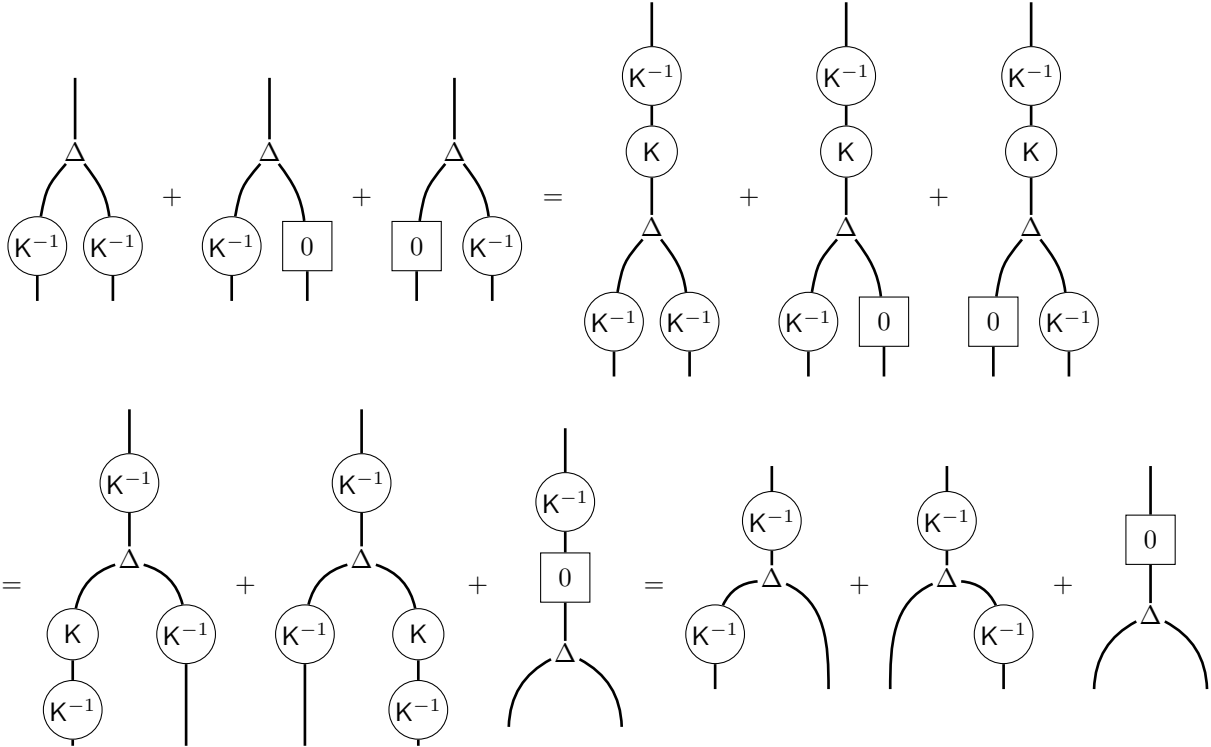

Table 6.6: Properties of K^{-1}

[K⁻¹.4]: Here we use [K.4], [K⁻¹.1] and naturality of Δ to first obtain the following equality:



Then we obtain the following equality:



$$= \begin{array}{c} \textcircled{K^{-1}} \\ | \\ \triangle \\ / \quad \backslash \\ \textcircled{K^{-1}} \quad | \end{array} + \begin{array}{c} \textcircled{K^{-1}} \\ | \\ \triangle \\ \backslash \quad / \\ | \quad \textcircled{K^{-1}} \end{array} + \begin{array}{c} | \\ \triangle \\ / \quad \backslash \\ \square \quad \square \\ | \quad | \\ 0 \quad 0 \end{array}$$

[$K^{-1}.5$]: Here we use [$K.10$]:

$$\begin{array}{c} \textcircled{K^{-1}} \\ | \\ \text{---} \\ / \quad \backslash \\ | \end{array} = \begin{array}{c} \textcircled{K^{-1}} \\ | \\ \text{---} \\ \text{---} \\ / \quad \backslash \\ | \\ \textcircled{K} \\ | \\ \textcircled{K^{-1}} \end{array} = \begin{array}{c} \textcircled{K^{-1}} \\ | \\ \textcircled{K} \\ | \\ \text{---} \\ / \quad \backslash \\ | \\ \textcircled{K^{-1}} \end{array} = \begin{array}{c} \text{---} \\ / \quad \backslash \\ | \\ \textcircled{K^{-1}} \end{array}$$

[$K^{-1}.6$]: Here we use [$K^{-1}.5$]:

$$\begin{array}{c} \textcircled{K^{-1}} \\ | \\ \text{---} \\ | \\ \text{---} \\ / \quad \backslash \\ | \end{array} = \begin{array}{c} \textcircled{K^{-1}} \\ | \\ \text{---} \\ \text{---} \\ / \quad \backslash \\ | \\ \text{---} \\ / \quad \backslash \\ | \end{array} + \begin{array}{c} | \\ \textcircled{K^{-1}} \\ | \end{array} = \begin{array}{c} \text{---} \\ / \quad \backslash \\ | \\ \text{---} \\ / \quad \backslash \\ | \\ \textcircled{K^{-1}} \end{array} + \begin{array}{c} | \\ \textcircled{K^{-1}} \\ | \end{array} = \begin{array}{c} \text{---} \\ | \\ \text{---} \\ / \quad \backslash \\ | \\ \text{---} \\ / \quad \backslash \\ | \\ \textcircled{K^{-1}} \end{array}$$

[K⁻¹.7]: Here we use [K.6], [K⁻¹.5] and [d.5]:

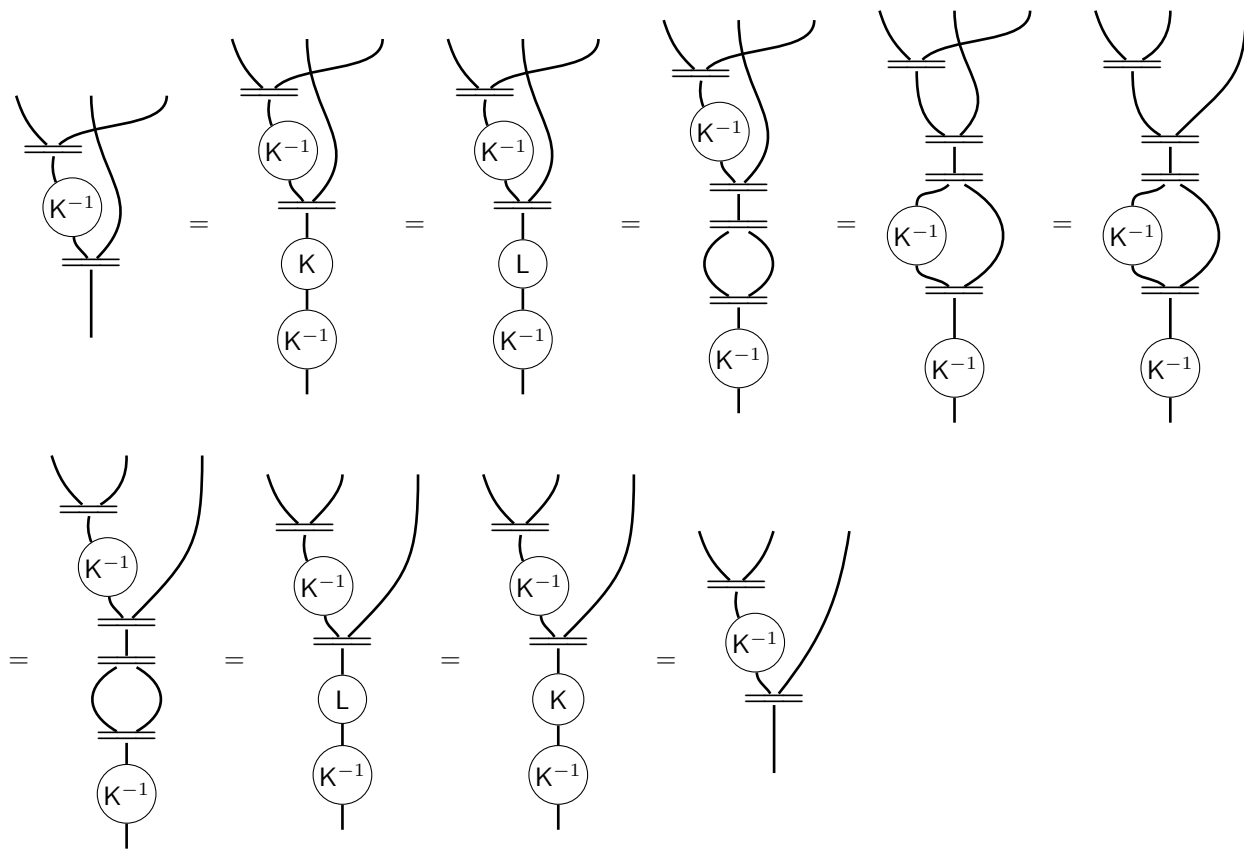

[K⁻¹.8]: Here we use [K.7], [K⁻¹.6] and [cd.7]:

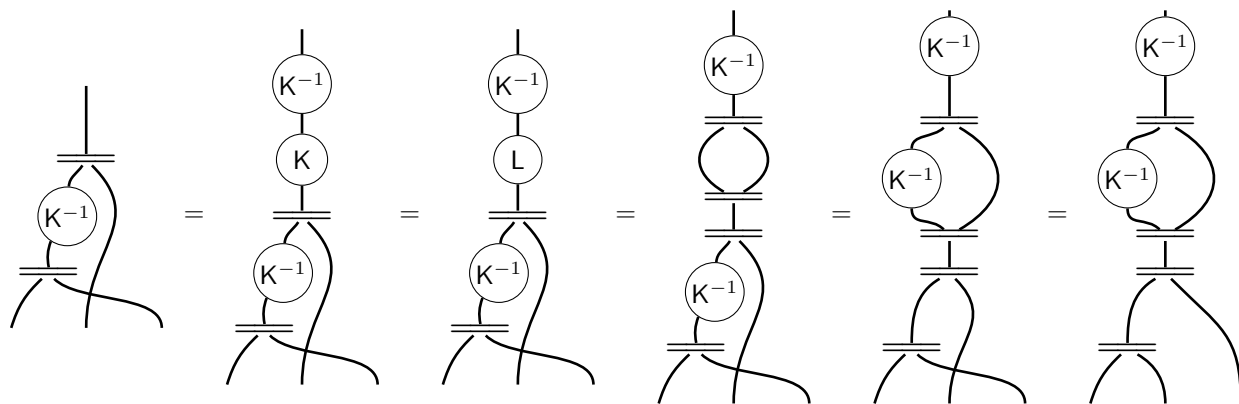

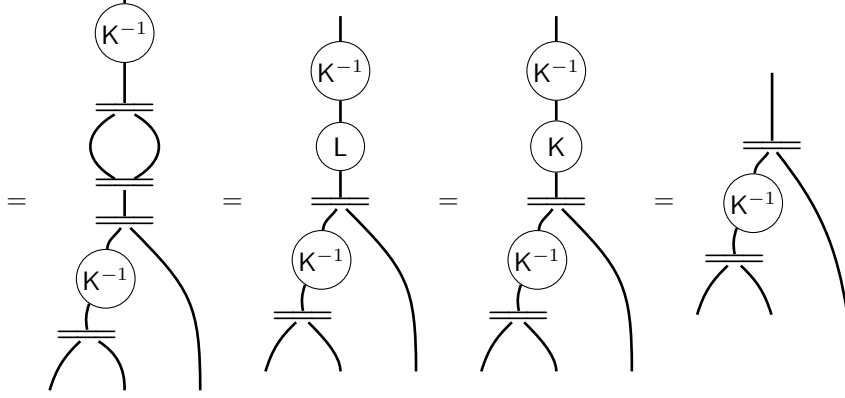

□

We will now give properties that the J^{-1} -map satisfies. Notice that the first seven hold without the assumption that the K map is also an isomorphism. However the last four requires the K^{-1} map. In particular, the last four will be important for the following section when we discuss the integral transformation.

Proposition 6.18. *The J^{-1} – map satisfies the following properties (see Table 6.7 for string diagrams) for each object $A \in Ob(\mathbb{X})$:*

$$[\mathbf{J}^{-1}.1] \quad J_A^{-1}!(0) = !(0) = !(0)J_A^{-1};$$

$$[\mathbf{J}^{-1}.2] \quad J_A^{-1}e_A = e_A;$$

$$[\mathbf{J}^{-1}.3] \quad 2 \cdot J_A^{-1}\varepsilon_A = \varepsilon_A;$$

$$[\mathbf{J}^{-1}.4] \quad (J_A^{-1} \otimes 1_A)d_A = d_A J_A^{-1} + (J_A^{-1} \otimes 1_A)d_A J_A^{-1};$$

$$[\mathbf{J}^{-1}.5] \quad d_A^\circ(J_A^{-1} \otimes 1_A) = J_A^{-1}d_A^\circ + J_A^{-1}d_A^\circ(J_A^{-1} \otimes 1_A);$$

$$[\mathbf{J}^{-1}.6] \quad (J_A^{-1} \otimes 1_A)W_A = W_A(J_A^{-1} \otimes 1_A);$$

$$[\mathbf{J}^{-1}.7] \quad (J_A^{-1} \otimes 1_A)d_A d_A^\circ = d_A d_A^\circ(J_A^{-1} \otimes 1_A);$$

$$[\mathbf{J}^{-1}.8] \quad (J_A^{-1} \otimes 1_A)d_A = d_A K_A^{-1};$$

$$[\mathbf{J}^{-1}.9] \quad d_A^\circ(J_A^{-1} \otimes 1_A) = K_A^{-1}d_A^\circ;$$

$$[\mathbf{J}^{-1}.10] \quad (\mathbf{d}_A \otimes 1_A)(\mathbf{J}_A^{-1} \otimes 1_A)\mathbf{d}_A = (1_A \otimes \sigma_{A,A})(\mathbf{d}_A \otimes 1_A)(\mathbf{J}_A^{-1} \otimes 1_A)\mathbf{d}_A;$$

$$[\mathbf{J}^{-1}.11] \quad \mathbf{d}_A^\circ(\mathbf{J}_A^{-1} \otimes 1_A)(\mathbf{d}_A^\circ \otimes 1_A) = \mathbf{d}_A^\circ(\mathbf{J}_A^{-1} \otimes 1_A)(\mathbf{d}_A^\circ \otimes 1_A)(1_A \otimes \sigma_{A,A}).$$

Proof. These are mostly straightforward calculations by using the properties of \mathbf{J} :

$[\mathbf{J}^{-1}.1]$: Here we use the property of \mathbf{J} :

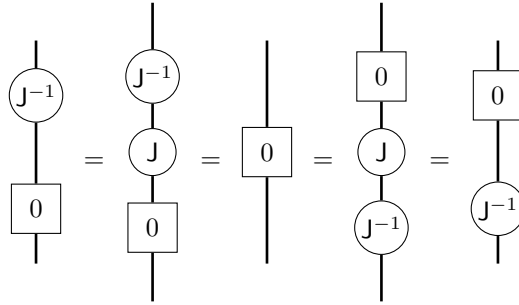

$[\mathbf{J}^{-1}.2]$: Here we use $[\mathbf{J}.2]$:

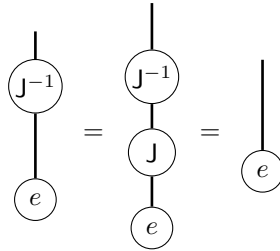

$[\mathbf{J}^{-1}.3]$: Here we use $[\mathbf{J}.3]$:

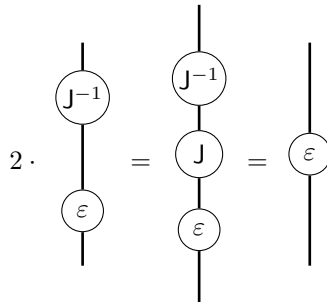

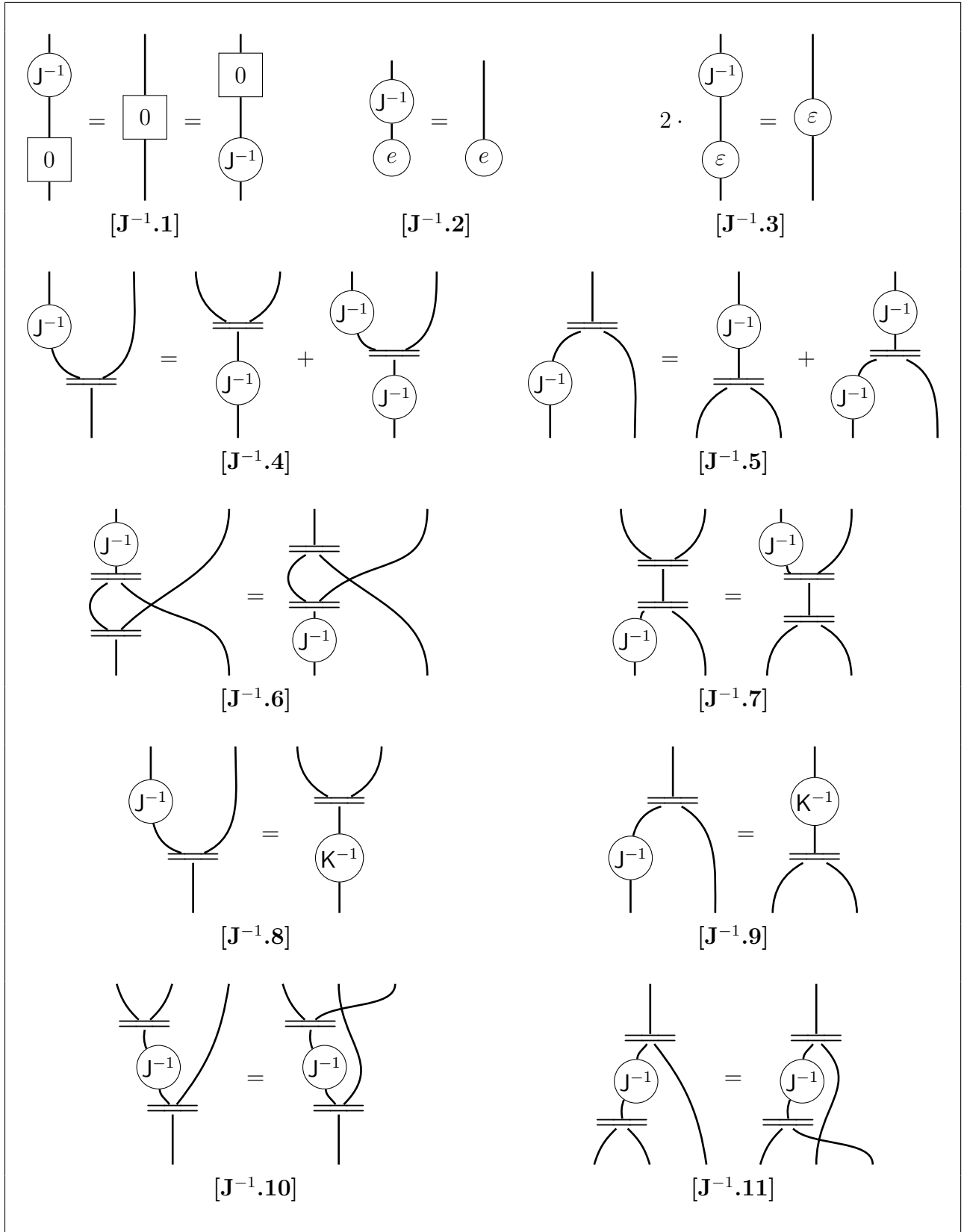
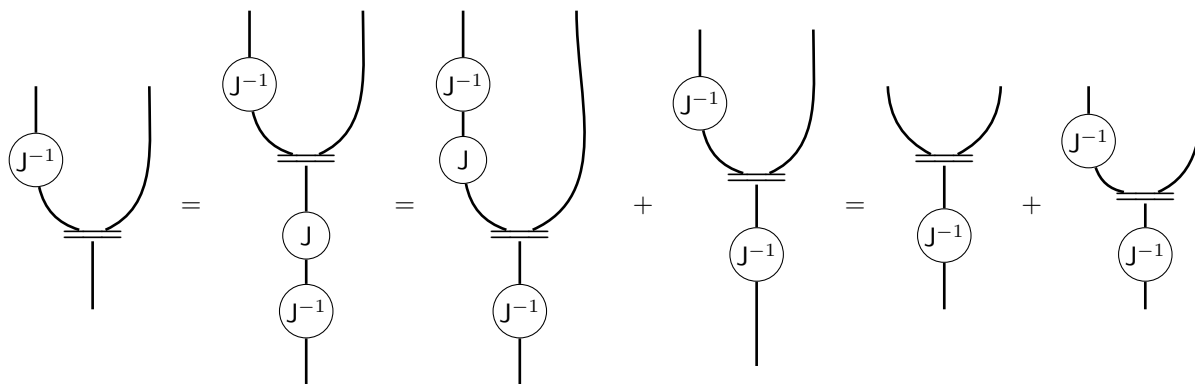
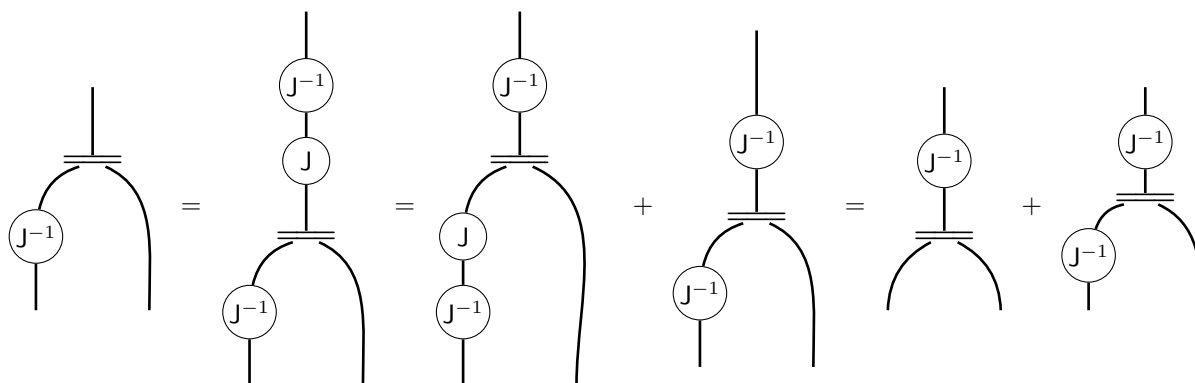

Table 6.7: Properties of J^{-1}

[J⁻¹.4] Here we use [J.8]:



[J⁻¹.5] Here we use [J.9]:



[J⁻¹.6]: Here we use [J.12]:

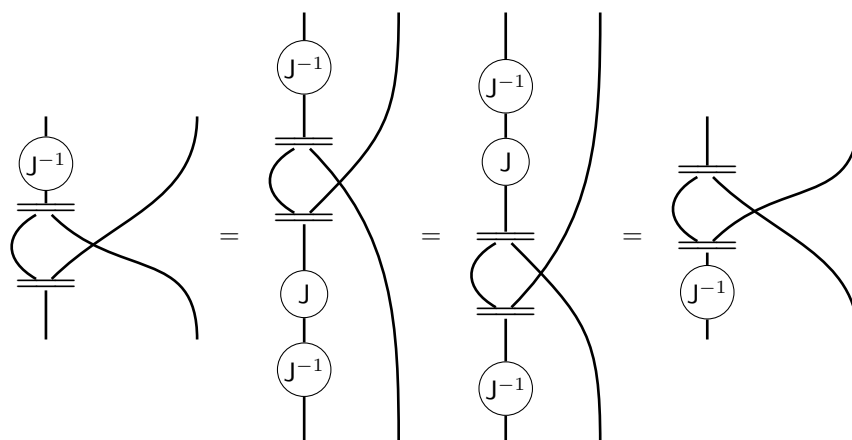

[$\mathbf{J}^{-1}.7$]: Here we use [$\mathbf{J}^{-1}.6$]:

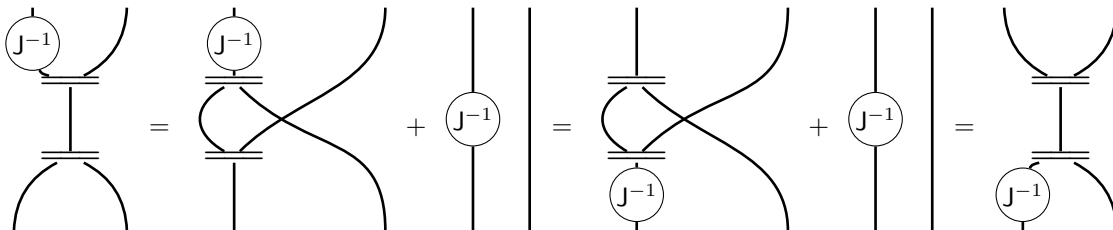

[$\mathbf{J}^{-1}.8$]: Here we use [$\mathbf{J}.6$]:

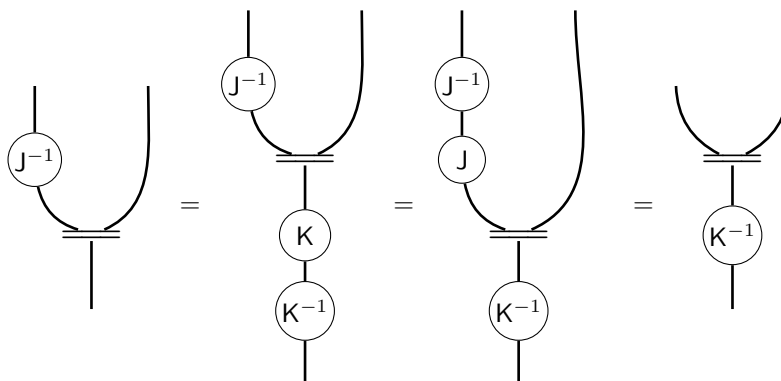

[$\mathbf{J}^{-1}.9$]: Here we use [$\mathbf{J}.7$]:

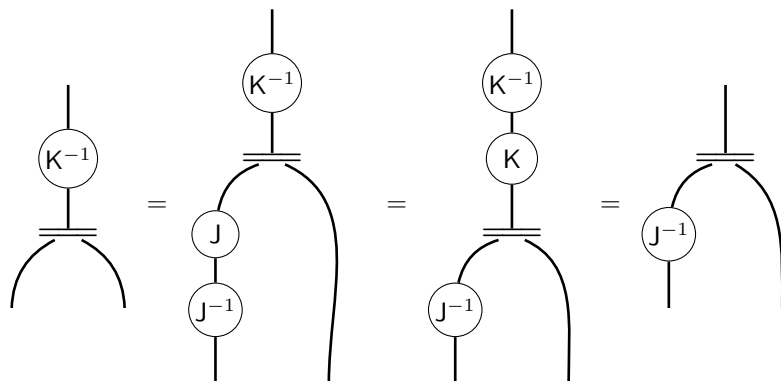

[J⁻¹.10]: Here we use [J⁻¹.8] and [d.5]:

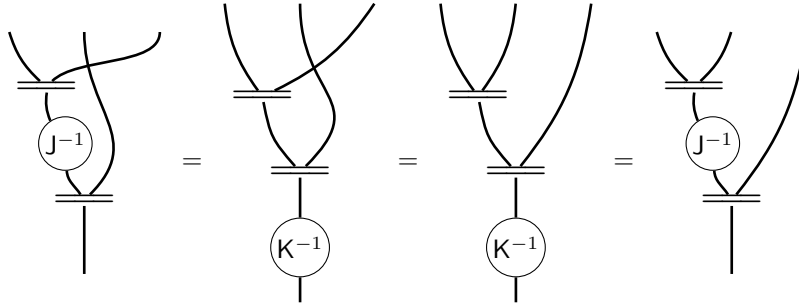

[J⁻¹.11]: Here we use [J⁻¹.9] and [cd.7]:

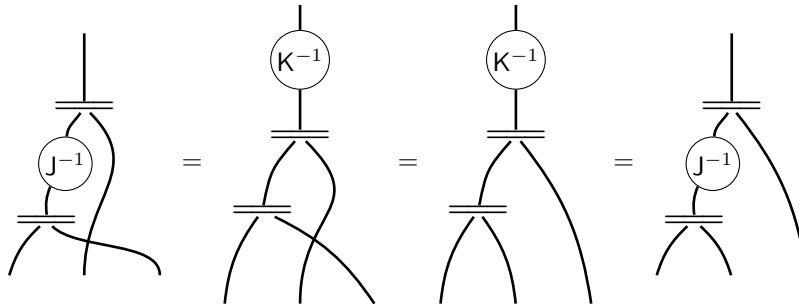

□

6.4 From Antiderivatives to Calculus Categories

In this section we prove that a differential category with antiderivative is a calculus category. This is the culmination of our work so far, thus it is the main result of this thesis. We begin by giving the definition of the antiderivative integral transformation which we then prove is an integral transformation and satisfies both the Second Fundamental Theorem of Calculus and the Poincaré Condition.

Definition 6.19. Let $(\mathbb{X}, \otimes, K, \lambda, \rho, \sigma)$ be a differential category with coalgebra modality $(!, \delta, \varepsilon, \Delta, e)$, deriving transformation \mathbf{d} and antiderivatives. The **antiderivative integral**

combinator P is a combinator of the functors $!(-) \otimes -, 1_{\mathbb{X}}, !$ and $1_{\mathbb{X}}$:

$$\frac{f : !A \otimes A \rightarrow B}{P[f] : !A \rightarrow B}$$

with $P[f] = K_A^{-1} d_A^\circ f = d_A^\circ (J_A^{-1} \otimes 1_A) f$. Equivalently, the **antiderivative integral transformation** is the natural transformation p with components $p_A : !A \rightarrow !A \otimes A$ defined as:

$$p_A = K_A^{-1} d_A^\circ = d_A^\circ (J_A^{-1} \otimes 1_A)$$

Notice that the equality $K_A^{-1} d_A^\circ = d_A^\circ (J_A^{-1} \otimes 1_A)$ is **[J⁻¹.9]** from Proposition 6.18. In string diagram notation, the antiderivative integral transformation is expressed as follows:

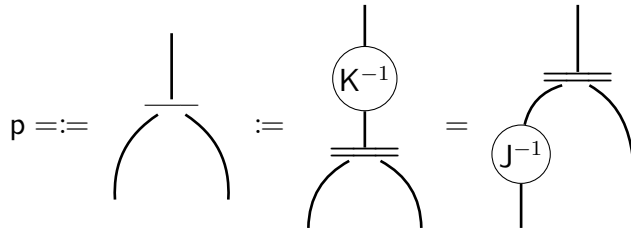

Now we will prove that the antiderivative integral transformation is indeed an integral transformation, which also satisfies the Second Fundamental Theorem of Calculus and the Poincaré condition. To prove the integral transformation axioms in Proposition 6.20 and the Second Fundamental Theorem of Calculus in Proposition 6.21 we use the K^{-1} form of the integral transformation. While to prove the Poincaré condition in Proposition 6.22 we use Ehrhard's J^{-1} .

Proposition 6.20. *A differential category which has antiderivatives is an integral category with respect to the antiderivative integral transformation, that is, the antiderivative integral transformation is an integral transformation.*

Proof. Since the antiderivative integral transformation is a composition of natural transformations, it is itself a natural transformation. We first show that the antiderivative integral

transformation satisfies [s.1] to [s.3].

[s.1]: Here we use [cd.1] and [K⁻¹.2]:

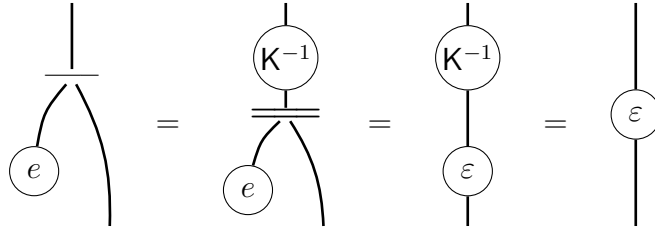

[s.2]: Here we use [K⁻¹.4], [cd.3], [cd.4] and naturality of the coderiving transformation:

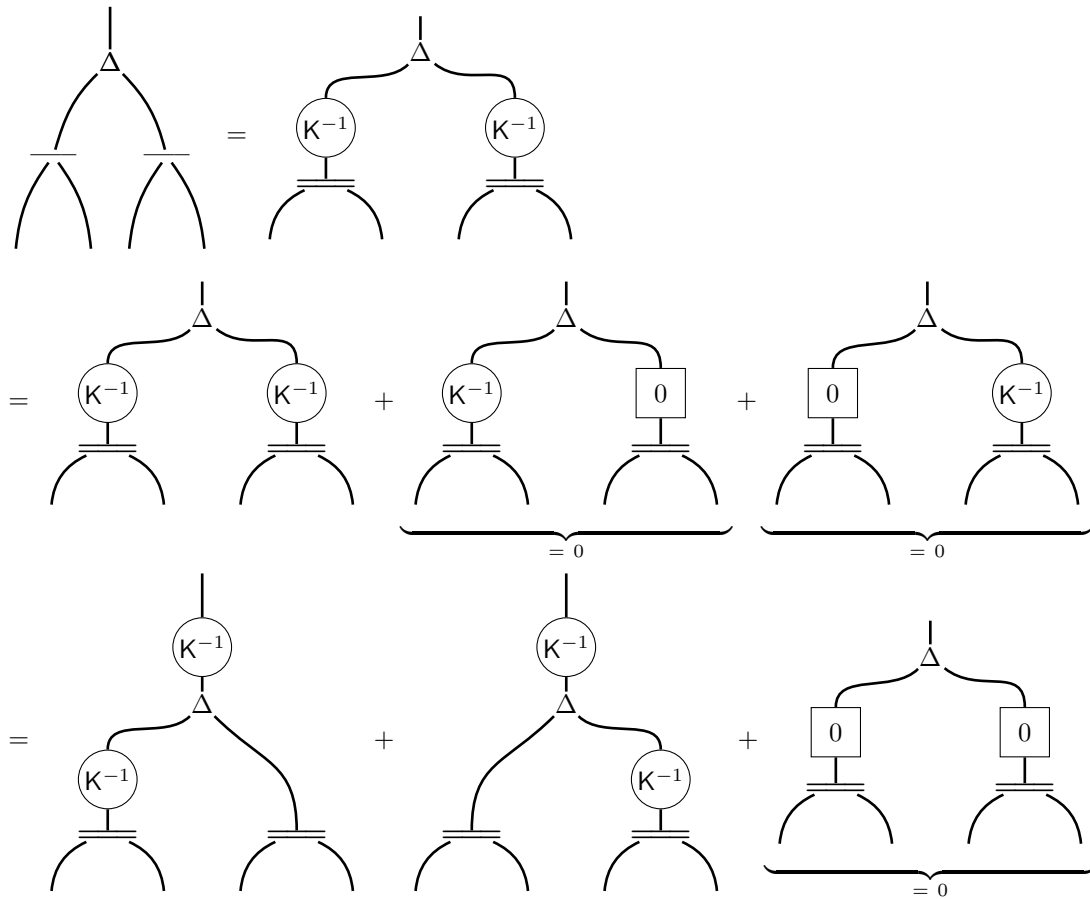

[s.3]: Here we use [K⁻¹.8]:

□

Proposition 6.21. *In a differential category which has antiderivative, the deriving transformation and the antiderivative integral transformation satisfies the Second Fundamental Theorem of Calculus.*

Proof. We show that antiderivative integral transformation and the deriving transformation satisfy the Second Fundamental Theorem of Calculus. Here we use that the K-map is an isomorphism and [K⁻¹.1]:

This also completes the proof of Proposition 6.13 that if K is a natural isomorphism, then the

deriving transformation is Taylor (since the Second Fundamental Theorem implies Taylor by Proposition 5.6). \square

Proposition 6.22. *In a differential category which has antiderivative, the deriving transformation and the antiderivative integral transformation satisfies the Poincaré Condition.*

Proof. We show that antiderivative integral transformation and the deriving transformation satisfy the Poincaré Condition. Let $f : !A \otimes A \rightarrow B$ be an integrable map which satisfies the Poincaré pre-condition, that is, $(1 \otimes \sigma_{A,A})(\mathbf{d}_A \otimes 1_A)f = (\mathbf{d}_A \otimes 1_A)f$. In string diagrams, the pre-condition is written as:

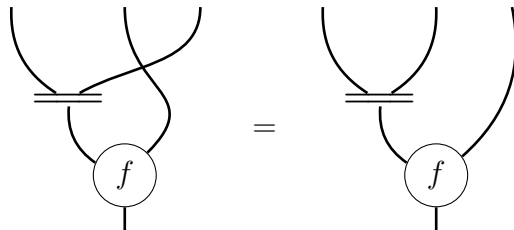

We must show that f satisfies the First Fundamental Theorem of Calculus. Notice first that f satisfies the following identity by using Proposition 6.6 and that f satisfies the Poincaré pre-condition:

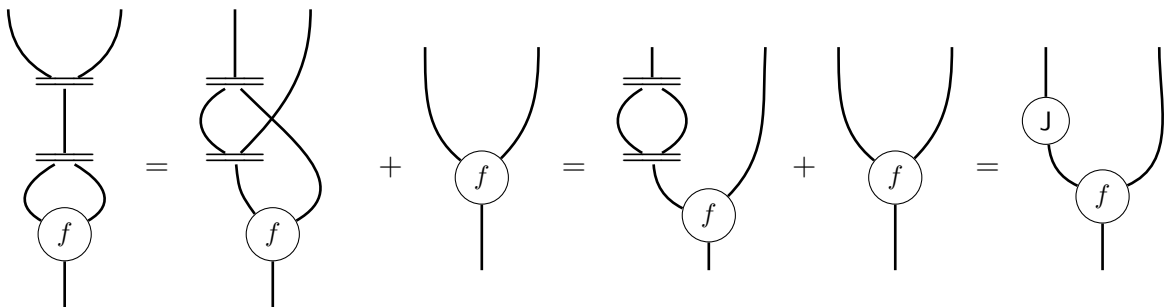

Then we have the following equality using [J⁻¹.7], [J⁻¹.9] and the preceding identity:

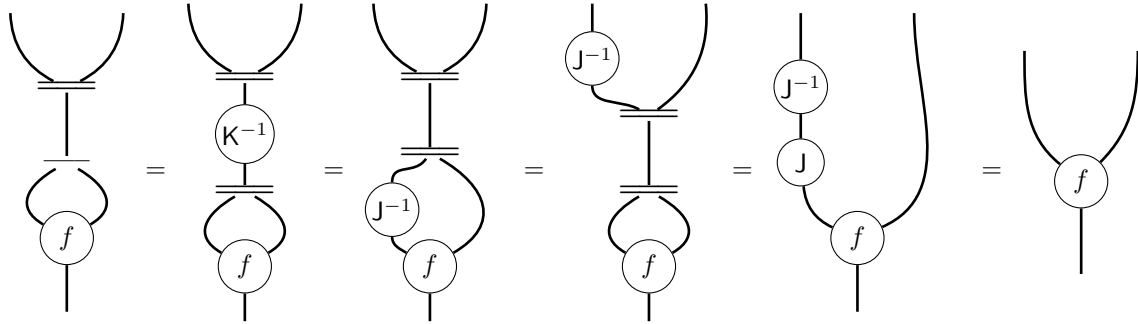

□

Theorem 6.23. *A differential category with antiderivatives is a calculus category.*

Proof. Proposition 6.20 gives the integral category structure while Proposition 6.21 and Proposition 6.22 give the calculus category structure by proving the Second Fundamental Theorem of Calculus and the Poincaré Condition respectively. □

For both of our main examples of calculus categories, REL and $\text{VEC}_{\mathbb{K}}$, the calculus category structure is induced from having antiderivatives.

Example 6.24. REL with the finite bag coalgebra modality (see Examples 3.13 and 4.9 for structure), is a calculus category.

Example 6.25. $\text{VEC}_{\mathbb{K}}$ with the free symmetric algebra modality (see Examples 3.15 and 4.11 for structure), is a calculus category.

Chapter 7

Conclusion and Future Work

To conclude this thesis, this chapter provides a brief summary of the original contributions that have been presented in this thesis, as well as an overview of various separating examples and a discussion of possible future research stemming from the present work.

7.1 Original Contributions

This thesis introduced integral categories, calculus categories, and differential categories with antiderivatives. The following recapitulates these contributions.

1. Integral Categories

Chapter 3, introduces integral categories. Two equivalent definitions of integral categories were presented: one using integral combinators (Definition 3.4) and the other using integral transformations (Definition 3.9), where the equivalence was proven in Proposition 3.12. Section 3.5 discussed and proved the polynomial integration formula for integral categories (Propositions 3.17, 3.18, and 3.19) and also how it implies non-negative rationals in an integral category (Propositions 3.20 and 3.24). Two examples of integral categories were provided with Example 3.15, the category of vector spaces over a fixed field of characteristic zero, and Example 3.13, the category of sets and

relations.

2. Calculus Categories

Chapter 5 introduces calculus categories. This chapter discusses how the Second Fundamental Theorem of Calculus (Definition 5.1) holds for every object in a calculus category while the First Fundamental Theorem of Calculus has to be reinterpreted as the Poincaré Condition (Definition 5.11). Proposition 5.6 proves that the Compatibility condition and the Taylor condition combined are equivalent to the Second Fundamental Theorem of Calculus. Conversely, Corollary 5.13 proves that the Poincaré Condition and Taylor condition imply the Second Fundamental Theorem of Calculus.

3. Antiderivatives

Chapter 6 introduces the definition of a differential category with antiderivatives. Section 6.2 introduced the L and K maps and showed how they relate to Ehrhard's J map. Proposition 6.13 states that K is invertible exactly when J is invertible and the deriving transformation is Taylor. Long lists of many properties of L , K , J , K^{-1} and J^{-1} were also provided (Propositions 6.10, 6.11, 6.12, 6.17 and 6.18). Two examples of differential categories with antiderivatives were provided with Example 6.16, the category of vector spaces over a fixed field of characteristic zero, and Example 6.15, the category of sets and relations. Section 6.4 proved the main result of this thesis, namely that every differential category with antiderivatives is a calculus category (Theorem 6.23).

7.2 Overview of Examples

Here we present an overview of separating examples between the various structures defined throughout this thesis, in particular, coalgebra modalities, differential categories, integral categories, calculus categories and differential categories with antiderivatives. We also include monoidal coalgebra modalities, which for the purpose of this thesis can be defined as coalgebra modalities with Seely isomorphisms (as discussed in Section 3.7), so

$!(A \times B) \cong !A \otimes !B$ and $!(0) \cong K$. We refer the reader to [5, 9] for the full definition and details of monoidal coalgebra modalities.

To help us give our separating examples, we present a Venn diagram with numbered regions, and a numerated list of example whose number is associated to the region in the Venn diagram. For example, the fourth item in the list below will be an example of a differential category which is not an integral category and whose coalgebra modality is not monoidal. We will not go into full details or prove anything for these examples, but will refer the reader the various excellent sources.

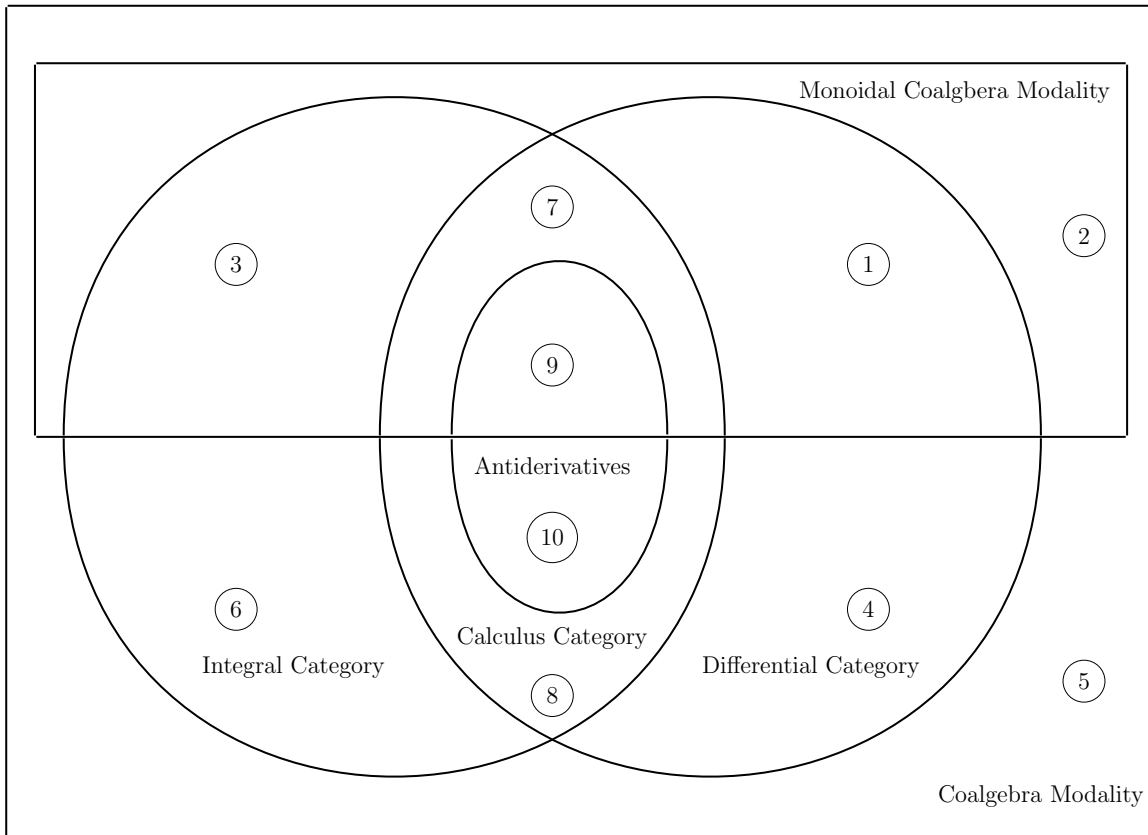

1. As seen with Propositions 3.20 and 3.24, integral categories always have non-negatives rationals. Therefore, we do not need to look very far for a differential category which

is not an integral category. As shown in Example 4.11, the category of vector spaces for any fixed field with the free symmetric algebra is a differential category. Then for a field with non-zero characteristic, such as \mathbb{Z}_2 , this is not an integral category. However, this algebra modality is comonoidal since the free symmetric algebra for any ring R has the Seelye isomorphisms: $\mathbf{Sym}(M \times N) \cong \mathbf{Sym}(M) \otimes \mathbf{Sym}(N)$ and $\mathbf{Sym}(0) \cong R$ [28].

2. Interestingly, one of the algebraic notions of differentiation does not give a differential category but does give a monoidal coalgebra modality and in certain cases also gives an integral category. Let R be a commutative ring. A (commutative) **differential algebra (of weight 0)** [22] over R is a pair (A, D) consisting of a commutative R -algebra A and an R -linear map $D : A \rightarrow A$ such that D satisfies the Leibniz rule, that is, the following equality holds:

$$D(ab) = D(a)b + aD(b) \quad \forall a, b \in A$$

Modifying slightly the construction given in [22] of the free differential algebra over a set to instead obtain a free differential algebra over an R -module, we obtain that the forgetful functor between the category of modules over R , \mathbf{MOD}_R , and the category of differential algebras over R , \mathbf{CDA}_R , has a left adjoint:

$$\mathbf{MOD}_R \begin{array}{c} \xrightarrow{\text{DIFF}} \\ \perp \\ \xleftarrow{U} \end{array} \mathbf{CDA}_R$$

Briefly, $\text{DIFF} : \mathbf{MOD}_R \rightarrow \mathbf{CDA}_R$ is defined on objects as $\text{DIFF}(M) = \mathbf{Sym}(\bigoplus_{n \in \mathbb{N}} M)$ and we refer the reader to [22] for the remainder of the construction (as it is similar). The induced monad of this adjunction is an algebra modality. This algebra modality has the Seelye isomorphisms since the free symmetric algebra does and the infinite coproduct

behaves well with the finite biproduct [28]:

$$\begin{aligned}
\text{DIFF}(M \times N) &= \text{Sym}\left(\bigoplus_{n \in \mathbb{N}} (M \times N)\right) \\
&\cong \text{Sym}\left(\bigoplus_{n \in \mathbb{N}} M \times \bigoplus_{n \in \mathbb{N}} N\right) \\
&\cong \text{Sym}\left(\bigoplus_{n \in \mathbb{N}} M\right) \otimes \text{Sym}\left(\bigoplus_{n \in \mathbb{N}} N\right) \\
&= \text{DIFF}(M) \otimes \text{DIFF}(N)
\end{aligned}$$

However this algebra modality does not have a deriving transformation, since the chain rule [d.4] will not be satisfied, and if R does not contain the rationals then it also will not have an integral transformation (as explained in the example of region 1). But as we will see in the example of region 3, when R does contain the rationals then the free differential algebra gives an integral category!

3. Continuing the example of region 2, letting R now be a field of characteristic zero (or a ring containing the rationals), we define an integral transformation for $\text{DIFF}(V)$ (where V is a vector space over R) component wise as follows:

$$\text{Sym}\left(\bigoplus_{n \in \mathbb{N}} V\right) \otimes V \xrightarrow{1 \otimes \iota_0} \text{Sym}\left(\bigoplus_{n \in \mathbb{N}} V\right) \otimes \bigoplus_{n \in \mathbb{N}} V \xrightarrow{\mathfrak{s}_{\bigoplus_{n \in \mathbb{N}} V}} \text{Sym}\left(\bigoplus_{n \in \mathbb{N}} V\right)$$

where $\iota_0 : V \rightarrow \bigoplus_{n \in \mathbb{N}} V$ is the injection map into the coproduct and $\mathfrak{s}_{\bigoplus_{n \in \mathbb{N}} V}$ is the integral transformation of the free symmetric algebra. Therefore, VEC_R with the free differential algebra monad is an integral category whose algebra modality is comonoidal.

4. Similar to the example of region 2, one of the algebraic abstractions of integration can give a differential category but not an integral category. That said, it is also possible to obtain a calculus category from the following example. Let R be a commutative ring. A (commutative) **Rota-Baxter algebra (of weight 0)** [21] over R is a pair (A, \mathbf{P}) consisting of a commutative R -algebra A and an R -linear map $\mathbf{P} : A \rightarrow A$ such

that P satisfies the Rota-Baxter equation, that is, the following equality holds:

$$P(a)P(b) = P(aP(b)) + P(P(a)b) \quad \forall a, b \in A$$

The map P is called a **Rota-Baxter operator** (we refer the reader to [21] for more details on Rota-Baxter algebras). It turns out that there is a left adjoint to the forgetful functor between the category of Rota-Baxter algebras, \mathbf{CRBA}_R , and the category of commutative algebras over R , \mathbf{CALG}_R (for more details on this adjunction and the induced monad see [23]).

$$\mathbf{CALG}_R \begin{array}{c} \xrightarrow{\text{RB}} \\ \perp \\ \xleftarrow{U} \end{array} \mathbf{CRBA}_R$$

Briefly, on objects the left adjoint $\text{RB} : \mathbf{CALG}_R \rightarrow \mathbf{CRBA}_R$ is given by $\text{RB}(A) = \text{Sh}(A) \otimes A$ where $\text{Sh}(A)$ is the shuffle algebra [21]. To obtain an algebra modality on the category of modules over R , \mathbf{MOD}_R , we compose the free Rota-Baxter algebra adjunction and the free symmetric algebra adjunction:

$$\mathbf{MOD}_R \begin{array}{c} \xrightarrow{\text{Sym}} \\ \perp \\ \xleftarrow{U} \end{array} \mathbf{CALG}_R \begin{array}{c} \xrightarrow{\text{RB}} \\ \perp \\ \xleftarrow{U} \end{array} \mathbf{CRBA}_R$$

and take the induced monad of this adjunction. This algebra modality, $\text{RB}(\text{Sym}(M))$, is not comonoidal as it does not have the Seely isomorphisms, explicitly, using that Sh is not a strong monoidal functor ($\text{Sh}(A \otimes B) \not\cong \text{Sh}(A) \otimes \text{Sh}(B)$) we have:

$$\begin{aligned} \text{RB}(\text{Sym}(M \times N)) &\cong \text{RB}(\text{Sym}(M) \otimes \text{Sym}(N)) \\ &= \text{Sh}(\text{Sym}(M) \otimes \text{Sym}(N)) \otimes \text{Sym}(M) \otimes \text{Sym}(N) \\ &\not\cong \text{Sh}(\text{Sym}(M)) \otimes \text{Sh}(\text{Sym}(N)) \otimes \text{Sym}(M) \otimes \text{Sym}(N) \\ &\cong \text{Sh}(\text{Sym}(M)) \otimes \text{Sym}(M) \otimes \text{Sh}(\text{Sym}(N)) \otimes \text{Sym}(N) \\ &= \text{RB}(\text{Sym}(M)) \otimes \text{RB}(\text{Sym}(N)) \end{aligned}$$

However, it does give a differential category. The components of the deriving transformation are defined as:

$$\mathrm{Sh}(\mathrm{Sym}(M)) \otimes \mathrm{Sym}(M) \xrightarrow{1 \otimes d_M} \mathrm{Sh}(\mathrm{Sym}(M)) \otimes \mathrm{Sym}(M) \otimes M$$

where d is the deriving transformation for the free symmetric algebra. Similarly to the examples of region 4, if R does not contain the rationals \mathbb{Q} , such as when the characteristic of R is non-zero, then this is not an integral category. But if R does contain \mathbb{Q} , such as when R is a field of characteristic zero, then this is a differential category with antiderivatives! And so would belong in region 10.

5. Combining the examples of region 2 and region 4, we obtain an example which is purely an algebra modality. Let R be a commutative ring. A (commutative) **differential Rota-Baxter algebra** [22] is a triple (A, D, P) consisting of a differential algebra (A, D) and a Rota-Baxter algebra (A, P) such that $PD = 1_A$. It turns out, that the free Rota-Baxter algebra over a differential algebra is also its free differential Rota-Baxter algebra, and therefore inducing the following adjunction between the category differential algebras, CDA_R , and the category of differential Rota-Baxter algebras, CDRBA_R :

$$\mathrm{CDA}_R \begin{array}{c} \xrightarrow{\mathrm{RB}} \\ \perp \\ \xleftarrow{U} \end{array} \mathrm{CDRBA}_R$$

The full construction can be found in [22]. Once again, to obtain an algebra modality, we compose this adjunction with the free differential algebra adjunction:

$$\mathrm{MOD}_R \begin{array}{c} \xrightarrow{\mathrm{DIFF}} \\ \perp \\ \xleftarrow{U} \end{array} \mathrm{CDA}_R \begin{array}{c} \xrightarrow{\mathrm{RB}} \\ \perp \\ \xleftarrow{U} \end{array} \mathrm{CDRBA}_R$$

This algebra modality is not comonoidal, for the same reasons as the example of region 4, and is not a differential category, failing the chain rule like the example of region 2. And again, if R does not contain the rationals, then this algebra modality is also not

an integral category.

6. Continuing the example of region 5, let R now be a field of characteristic zero. We define an integral transformation for $\text{RB}(\text{DIFF}(V))$ similarly to that of the example of region 3, component wise as follows:

$$\begin{aligned} & \text{Sh}(\text{Sym}(\bigoplus_{n \in \mathbb{N}} V)) \otimes \text{Sym}(\bigoplus_{n \in \mathbb{N}} V) \otimes V \xrightarrow{1 \otimes 1 \otimes \iota_0} \\ & \text{Sh}(\text{Sym}(\bigoplus_{n \in \mathbb{N}} V)) \otimes \text{Sym}(\bigoplus_{n \in \mathbb{N}} V) \otimes \bigoplus_{n \in \mathbb{N}} V \xrightarrow{1 \otimes s_{\bigoplus_{n \in \mathbb{N}} V}} \\ & \text{Sh}(\text{Sym}(\bigoplus_{n \in \mathbb{N}} V)) \otimes \text{Sym}(\bigoplus_{n \in \mathbb{N}} V) \end{aligned}$$

Then VEC_R with the free differential Rota-Baxter algebra monad is an integral category whose algebra modality is not comonoidal.

7. We currently do not have an example of a calculus category whose coalgebra modality is monoidal which is not a differential category with antiderivatives. See next item for further explanation.
8. We currently do not have an example of a calculus category which is not a differential category with antiderivatives. It has been quite difficult to come across, since we can show that most calculus category structures on the category of vector spaces over a fixed field of characteristic zero are given by antiderivatives. However, we believe that such a separating example exists as one exists for the cartesian analogue (see Section 7.3 for a brief discussion about cartesian integral categories).
9. The coalgebra modalities of the two main examples of differential category with antiderivatives given in this thesis, the category of vector spaces over a fixed field of characteristic zero with the free symmetric algebra monad (Example 6.16), and the category of sets and relations with the finite bag comonad (Example 6.15), are both monoidal coalgebra modalities.

10. We have already given an example for this region, with the free Rota-Baxter algebra (as explained above), but we present another two other example: a trivial one and a non-trivial one. Starting with the trivial example, let R be a non-zero commutative ring. The zero R -module, 0 , induces a coalgebra modality on the category of modules over R where the functor maps all objects to 0 and all maps to zero maps. This coalgebra modality is not monoidal since $!(0) = 0 \not\cong R$. It is however a differential category with antiderivatives since every map in sight would be zero and the necessary equalities hold trivially. This example can be generalized to any additive symmetric monoidal category with a zero object. For a non-trivial example, we turn our attention to algebras which are additively idempotent, that is, when $1 + 1 = 1$. Similar to the construction of the free symmetric algebra for the category of vector spaces over a field, one can construct the free additively idempotent commutative algebra in the category of modules over a rig [20], which gives an algebra modality. The deriving transformation is the same as the free symmetric algebra, and since our algebra is additively idempotent: K and J are the identity! Therefore, this is a differential category with antiderivatives. However, if the rig R is not additively idempotent (such as \mathbb{N}), this is not a comonoidal algebra modality since $!(0) \not\cong R$. When R is additively idempotent, then the algebra modality does have the Seelye isomorphisms and this example would belong to region 9.

7.3 Future Work

A reasonable strategy for developing the theory of integral categories is to follow the same path as differential categories. The theory of differential categories was developed in four stages with each stage formalizing a different aspect of the theory of differentiation: (tensor) differential categories [8] formalize basic differentiation, cartesian differential categories axiomatize directional derivatives [10], restriction differential categories [13] formalize the theory of differentiation on open subsets, and tangent categories [14] formalize tangent struc-

ture and the theory of smooth manifolds. Each stage relates to the next in interesting ways: the coKleisli category of a differential category is a cartesian differential category, while a cartesian differential category is a special case of a restriction differential category. Restriction differential categories, in turn, have an associated manifold completion which is itself a tangent category.

As shown in this thesis, integral categories are closely related to differential categories. Therefore, it seems worthwhile to develop a parallel approach for integral categories in four corresponding stages. In this thesis, we have developed the first step with (tensor) integral categories. The next obvious step is to develop cartesian integral categories and cartesian calculus categories, and in particular, to show that the coKleisli category of an integral category is a cartesian integral category. Afterwards, we will develop restriction integral categories, which should formalize the theory of integration on open subsets, and finally study integration in tangent categories, where hopefully the two stages should be related through a manifold completion. We hope to obtain abstract formalizations and explanations of classical results of integration such as partial integration, Gauss' theorem and Stoke's theorem.

Bibliography

- [1] S. Awodey *Category Theory 2nd Edition*. Oxford Logic Guides, Oxford University Press, 2010.
- [2] M. Barr **-Autonomous Categories*. Lecture Notes in Mathematics, Springer, 1979.
- [3] M. Barr and C. Wells, *Category Theory for Computing Science*, Prentice Hall, 2nd edition, 1995.
- [4] G. Baxter, *An analytic problem whose solution follows from a simple algebraic identity*, Pacific J. Math.10, 731-742, 1960.
- [5] G. Bierman *What is a categorical model of intuitionistic linear logic*. LNCS vol.92 pp73-93, 1995.
- [6] R. Bott, L. W. Tu, *Differential Forms in Algebraic Topology*. Graduate Texts in Mathematics, Springer-Verlag, Berlin, Heidelberg, New York, 1982.
- [7] R. Blute, R. Cockett, T. Porter, R. Seely, *Kahler Categories*, Cahiers de Topologie et Geometrie Differentielle 52, pp. 253-268, 2012.
- [8] R. Blute, R. Cockett, R. Seely, *Differential Categories*, Mathematical Structures in Computer Science Vol. 1616, pp 1049-1083, 2006.
- [9] R. Blute, R. Cockett, R. Seely, *Cartesian Differential Storage Categories*, Theory and Applications of Categories 30, pp. 620-686, 2015.

- [10] R. Blute, R. Cockett, R. Seely, *Cartesian Differential Categories*, Theory and Applications of Categories 23, pp. 622-672, 2009
- [11] R. Blute, R. Lucyshyn-Wright, K. O'Neill, *Derivations in Codifferential Categories*, arXiv:1505.00220, 2015.
- [12] F. Borceux, *Handbook of Categorical Algebra 1: Basic Category Theory*, Encyclopedia of Mathematics and its Applications, Cambridge University Press, 1994.
- [13] R. Cockett, G. Cruttwell, J. Gallagher *Differential restriction Categories.*, Theory and Applications of Categories, 21, pg. 537-613, 2011.
- [14] R. Cockett, G. Cruttwell *Differential structure, tangent structure, and SDG.*, Applied Categorical Structures, 22 (2), pg. 331-417, 2014.
- [15] T. Ehrhard *An introduction to Differential Linear Logic: Proof-Nets, Models and Antiderivatives.* Mathematical Structures in Computer Science, 2015.
- [16] T. Ehrhard, L. Regnier, *The differential λ -calculus.*, Theoretical Computer Science 309(1-3), 1-41, 2003.
- [17] T. Ehrhard, L. Regnier, *Differential interaction nets.*, Workshop on Logic, Language, Information and Computation (WoLLIC), invited paper. Electronic Notes in Theoretical Computer Science, vol. 123, Elsevier, 2005.
- [18] M.P. Fiore, *Differential structure in models of multiplicative biadditive intuitionistic linear logic*, In Typed Lambda Calculi and Applications, Lecture Notes In Computer Science 4583. Springer-Verlag, 163-177, 2007.
- [19] J-Y. Girard, *Linear Logic.*, Theoretical Computer Science, Vol 50, no. 1, pp. 1102, 1987.
- [20] J. S. Golan *Semirings and their Applications.* Springer Netherlands, 1999.

- [21] L. Guo, *An Introduction Rota-Baxter Algebra*, Surveys of Modern Mathematics, Volume IV, 2012.
- [22] L. Guo and W. Keigher, *On differential Rota-Baxter algebras*, J. Pure Appl. Algebra 212,522540, 2008.
- [23] L. Guo, W. Keigher, S. Zang *Monads and distributive laws for Rota-Baxter and differential algebras*, Advances in Applied Mathematics, Volume 72, 139-165, 2016.
- [24] A. Joyal, R. Street, *The geometry of tensor calculus i*, Advances in Mathematics, 88(1):55-122, 1991.
- [25] G. M. Kelly, *On MacLane's Conditions for Coherence of Natural Associativities, Commutativities, etc.*, Journal of Algebra 1, 397-402, 1964.
- [26] G. M. Kelly, *Basic Concepts of Enriched Category Theory*, London Mathematical Society Lecture Note Series No. 64. Cambridge University Press, 1982.
- [27] J. Laird, G. Manzonetto, G. McCusker, *Constructing differential categories and deconstructing categories of games.*, Information and Computation, vol.222, 247-264, 2013.
- [28] S. Lang, *Algebra*, Graduate Texts in Mathematics, Springer-Verlag, Berlin, Heidelberg, New York, 2002.
- [29] S. Mac Lane, *Categories for the Working Mathematician*, Graduate Texts in Mathematics, Springer-Verlag, Berlin, Heidelberg, New York, 1971.
- [30] G. Manzonetto, *What is a categorical model of the differential and the resource λ -calculus?*, Mathematical Structures in Computer Science, 22(3): 451-520, 2012.
- [31] P-A. Mellies *Categorical models of linear logic revisited.* pps//03/09//n22 (pp) jhal-00154229_v, 2003.

- [32] G-C. Rota, *Baxter algebras and combinatorial identities, I, II*, Bull. Amer. Math. Soc. 75 (2): 325-329, 330-334, 1969.
- [33] P. Selinger, *A survey of graphical languages for monoidal categories*, New structures for physics, p. 289-355, Springer, 2011.
- [34] A. Shalk *What is a categorical model for linear logic*. 2004.
- [35] C. Weibel *An Introduction to Homological Algebra*, Volume 38 of Cambridge Studies in Advanced Mathematics, Cambridge University Press, 1995