



UNIVERSITY OF CALGARY

University of Calgary

PRISM: University of Calgary's Digital Repository

Research Centres, Institutes, Projects and Units

E-Health Resource Repository

2003-03-06

Security Restricts Legitimate Use, But Does it Have To? Consider persistent info security and everytime tracking.

Matson, Merv

RightsMarket Inc.

Matson Merv. 2003. Security Restricts Legitimate Use, But Does it Have To? Consider persistent info security and everytime tracking. Calgary, AB: RightsMarket Inc. Presented at the EU-Canada Workshop held in Ottawa, Ontario on March 6th, 2003

<http://hdl.handle.net/1880/43129>

Presentation

Downloaded from PRISM: <https://prism.ucalgary.ca>

Security Restricts Legitimate Use, But Does It Have To?

Consider
Persistent Info Security
and Everytime Tracking

EU-Canada Workshop
Ottawa, Canada
2003-Mar-06

Merv Matson, *Chairman and Founder*
RightsMarket, Inc.
MatsonM@RightsMarket.com
(403) 571-1836

Legitimate Use

- Physician with clinical system has onscreen report to share
 - Print, in order to fax, mail, courier, send with patient
 - Email? Offer via Net? Send on floppy disk? Probably not due to security concerns.
- Physician with just a report to send to a colleague, or the patient.
 - Email it?

EMR

X-Ray Reports
Cumulative History

Laboratory Reports
Progress Note

Correspondence
Patient Summary

ER Visits
Medications

[VIEW X-RAY REPORT DETAILS](#)

Patient: PATE, KEVIN M

X-Ray Facility:	OROMOCTO PUBLIC HOSPITAL
Tests Ordered:	BONE SCAN WHOLE BODY
Ordered By:	DR. BILL SMITH
Date Ordered:	FRIDAY, SEPTEMBER 10, 2001
Date Filed:	WEDNESDAY, OCTOBER 3, 2001
Filed By:	DR. BILL SMITH
Radiologist:	DR. JOHN COLLINS
Image On File?	YES

Comments:

BONE SCAN

There is satisfactory uptake and distribution of tracer in bone and both kidneys. There appears to be mild increased activity along the posterior aspect of the left 7th rib suggesting possible periosteal reaction or other abnormality at this site. There is also mild increased activity at the left pedicle of L2 or the adjacent facet joint. Mild increased activity is noted at the left sternoclavicular joint.

Findings are otherwise unremarkable.

SAVE REPORT AS FILE



- Scheduler Summary
- Select Patient
- System Menu
- Billing
- MAST Utilities
- Office Actions
- Manage Patients
- Close Window
- Logout

eMail Secure Attachments



Information Security Breaches

- Repository - break in through Net
- Delivery - intercepted during Net transit
- User - leak from point of legitimate use, by
 - User info accident (email, common location)
 - User malice
 - Theft via break in through Net

Channel Security

Record is safe during transit

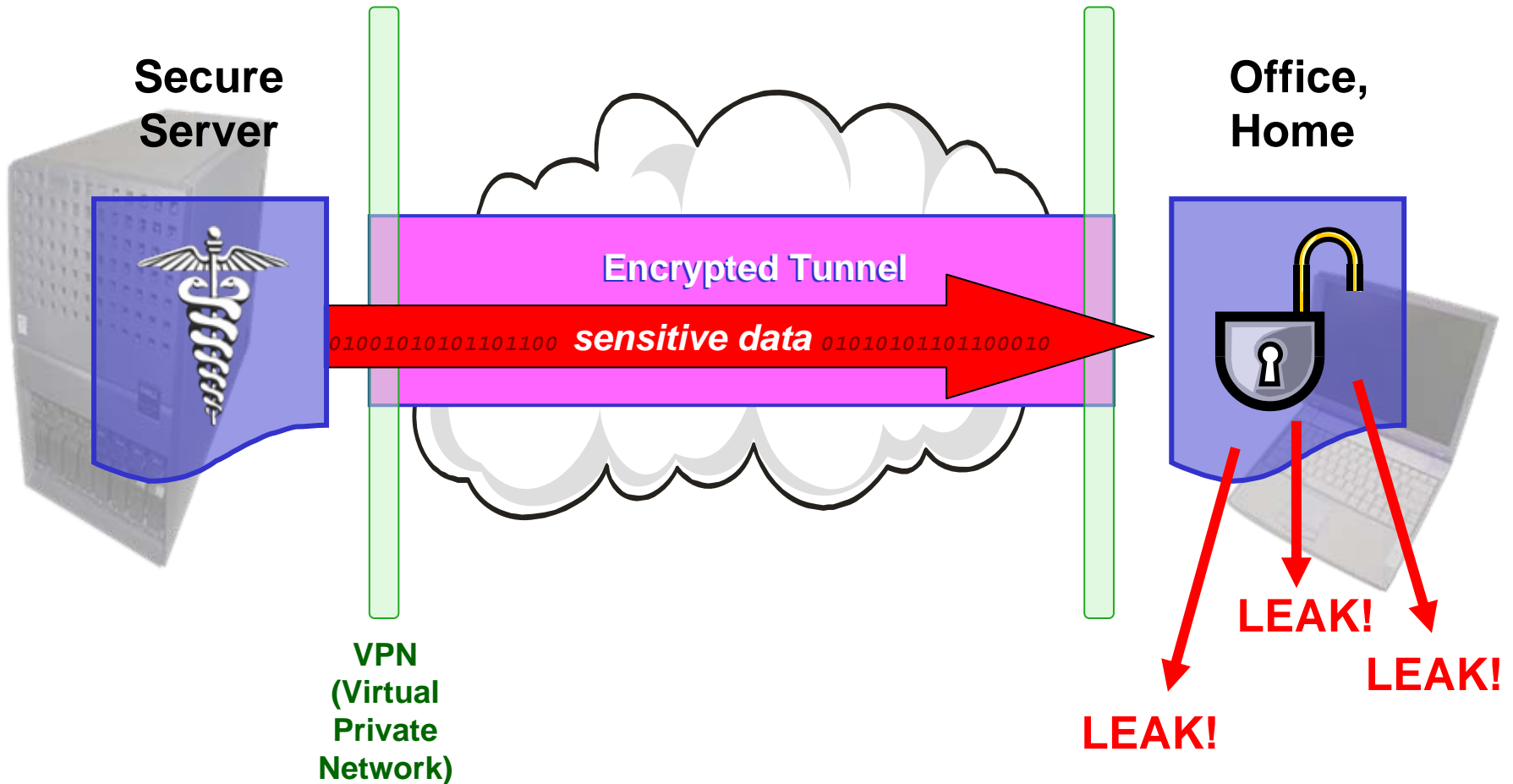

Lock-Unlock Security

Record is secure until unlocked

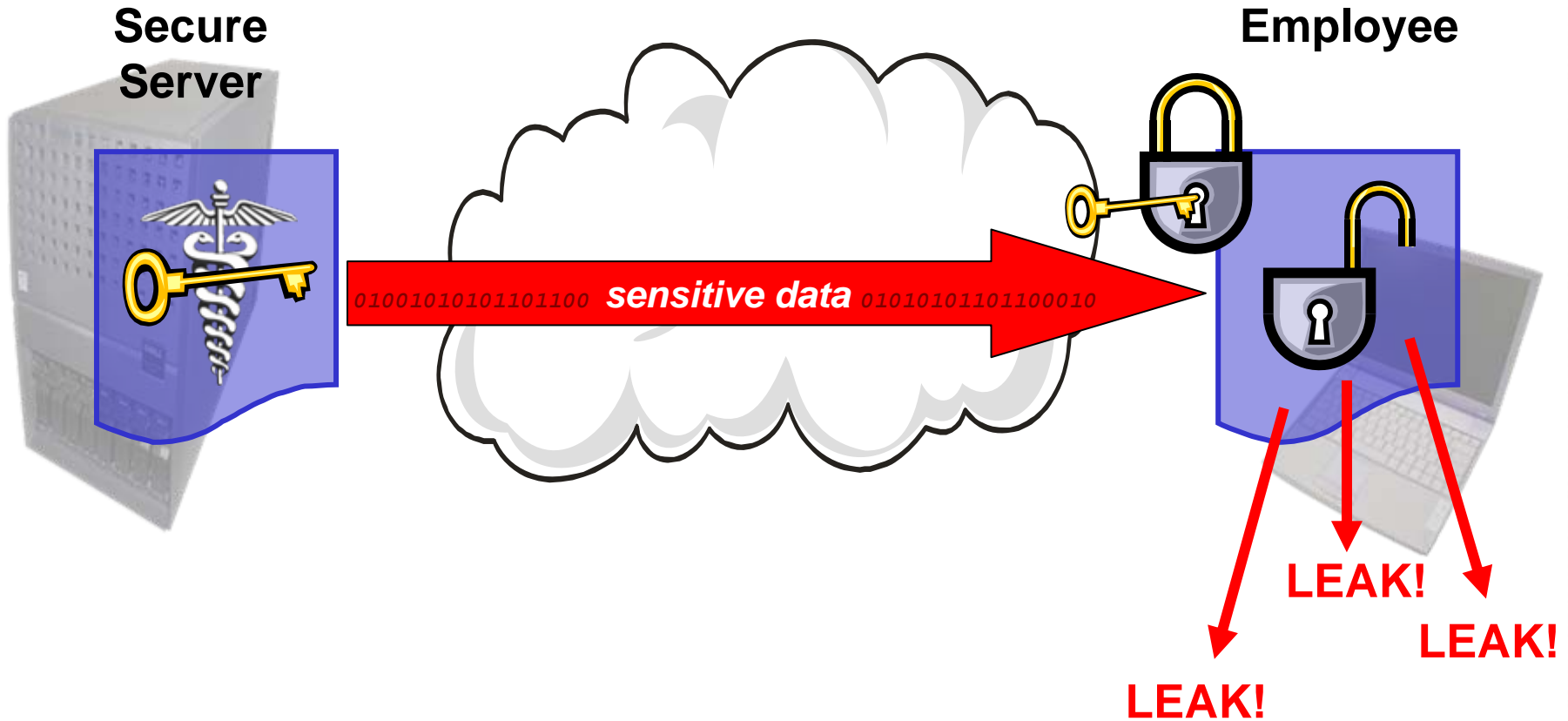

Persistent Security

Record is safe at all times, everywhere

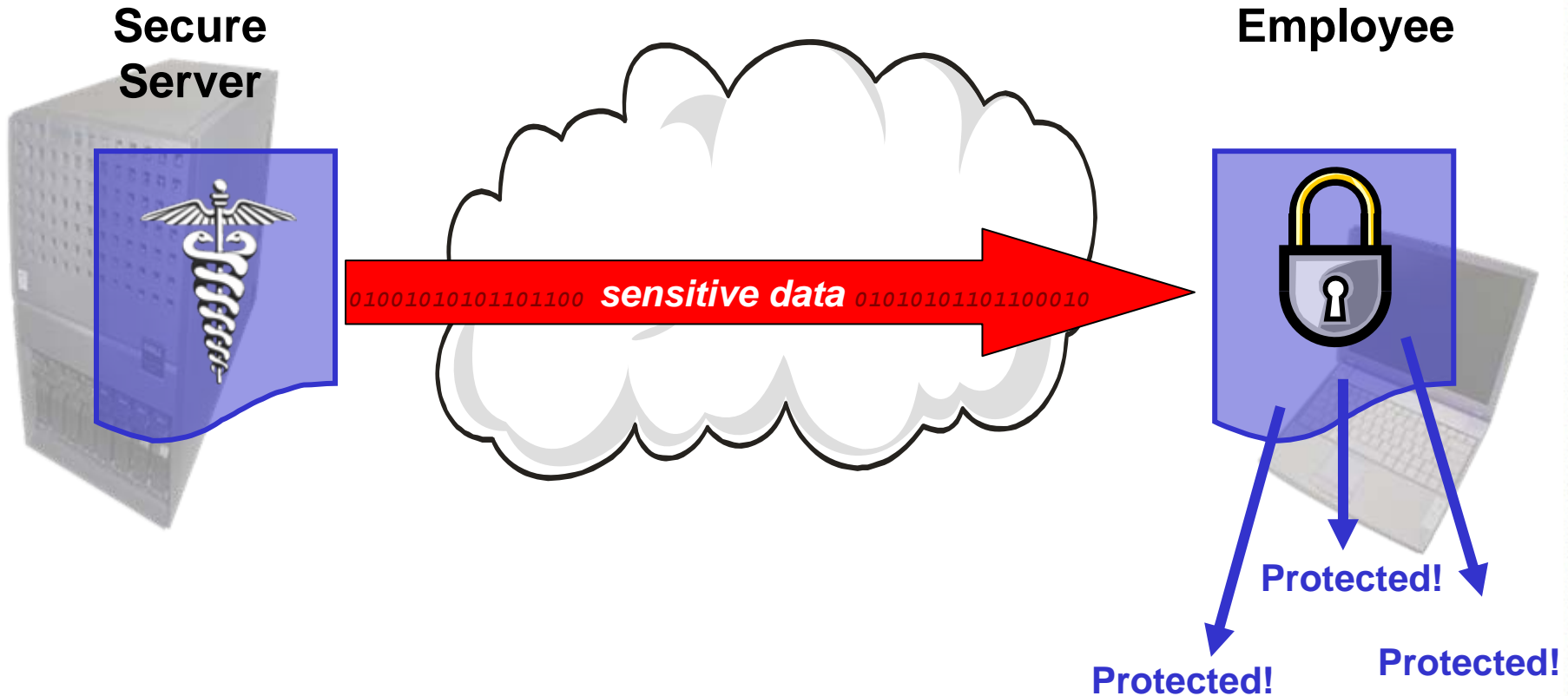

Not Just Delivery Security

Persistent Security & Use Tracking

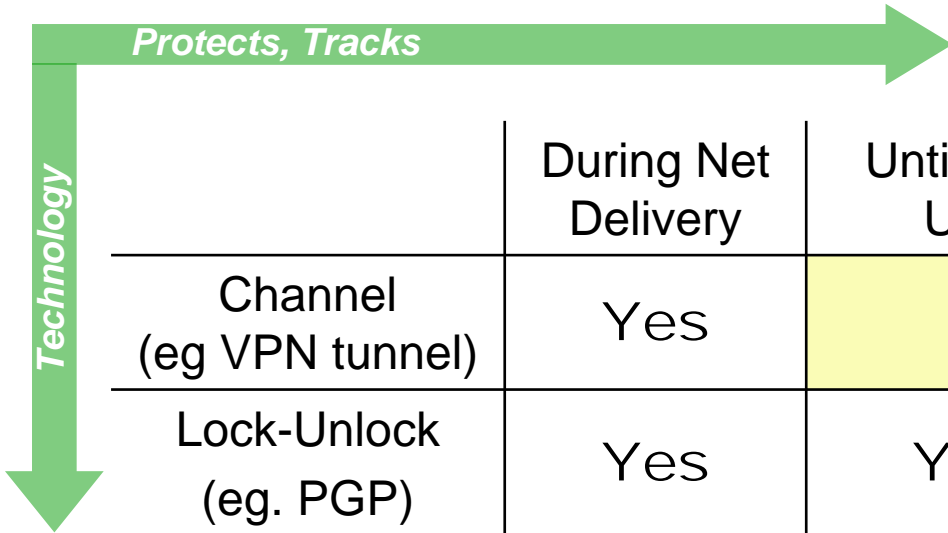

	During Net Delivery	Until First Use	Every time, Everywhere
Channel (eg VPN tunnel)	Yes		
Lock-Unlock (eg. PGP)	Yes	Yes	
Persistent	Yes	Yes	Yes

www.OttawaHeart.ca/hcraschr.htm

Regionally Accessible Secure Cardiac Health Records

- RASCHR is an on-line patient record system that provides authorized healthcare workers in hospitals and clinics in Eastern Ontario immediate access to cardiac health records of patients who have catheterization or cardiac surgery at the University of Ottawa Heart Institute.
- A main function – effect online referral from regional hospital to Ottawa Heart

RASCHR – Online Patient Registry

University of Ottawa Heart Institute - OPR - Microsoft Internet Explorer

File Edit View Favorites Tools Help

Back Forward Stop Refresh Home Search Favorites Media Print Mail

Address http://design.xwave.com/oprprototype/QA_view_full.html Go Links

OPR University of Ottawa Heart Institute **Online Patient Registry** QUALITY ASSURANCE

Patient Summary

New Lists Search+ Print

Name: Jones, Brent M Date of Birth: 1962-05-26 Age: 39 Sex: Male

Health Insurance: 1133133235 ON UOHI Unique Number: 344212

Status: **CATH** **SURG** **PCI**

Jones, Brent Mark

- Demographics
- Referrals
 - 400012 2001-09-12
 - GEN INFO General
 - CATH 2000-09-12
 - PCI 2000-09-13
 - SURG 2000-09-14
 - SURG 2000-09-15
 - SURG 2000-09-14
 - 400013 2000-06-23
 - 400014 2000-03-01
 - 400015 2000-02-11
 - GEN INFO General
 - NEW

Referral - Surgery Report

General Surgery Rounds Risk Stratification

Female Gender:	1
Age: 70-74	7
75-79	12
>80	20
Obesity: > 1.5 X ideal	3
Hypertension: > 140/	3
Diabetes:	3
CHF: NYHA III	2
NYHA IV	6
Right Heart Failure:	2
Pulmonary Hypertension: > 40 / 100	1

Online System, Extra Info

- The information that can be included in the online referral may be incomplete
 - Referror has an important lab report
 - Heart Institute needs to send report back
- Send paper somehow?
- Better to send report as persistently secured email attachment.

Policy & Peer Permission System

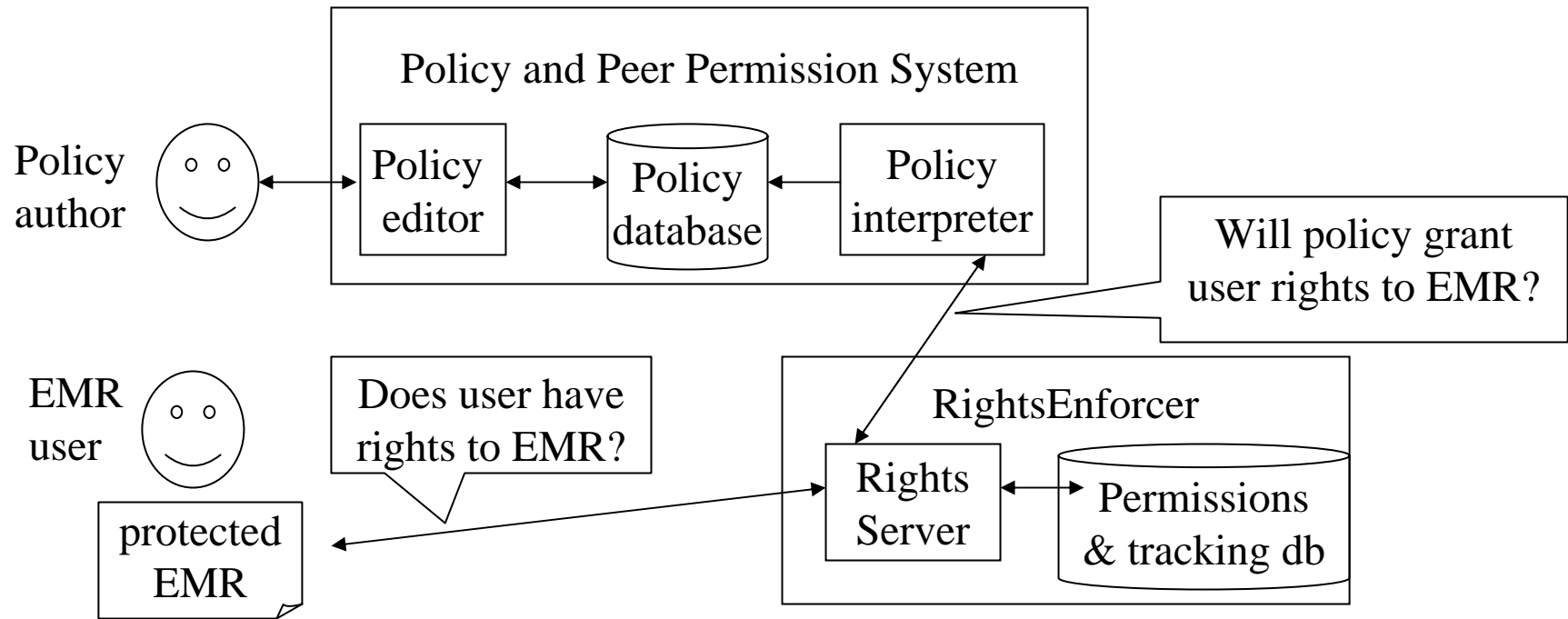

RightsMarket Inc, lead, SW devel
UCalgary Health Telematics, policy
UOttawa Heart Institute, deployment
CANARIE Inc, eHealth funding

Now in test deployment at Heart
Institute and other eastern Ontario
hospitals participating in RASCHR
Project.

Policy and Peer Permission System

The screenshot shows a web browser window with the URL `http://ws.rightsmarket.com/ppppolicyadmin/Secure/Rule...`. The browser's address bar shows `http://ws.rightsmarket.com/ppppolicyadmin/Secure/Rule.aspx?Rule=3`. The page title is "RightsEnforcer". On the left side, there is a navigation menu with links for [Logout](#), [Assignments](#), [Caregivers](#), [Groups](#), [Policy](#), and [Tracking](#). The main content area is titled "Policy Statement Authoring" and includes a language dropdown set to "English". Below this, the text reads "Patient in System and Caregiver User within assigned Caregiver's Group". A form contains a "Permission to:" dropdown set to "View and Print", followed by "granted if Patient in system:" with a dropdown set to "OPR", and "and Patient assigned to Caregiver User". A button labeled "Add a New Policy Statement" is present. A tooltip box explains: "Click here to create a parameterized instance of the Policy Class. Once created, the instance is used in determining Policy based access rights to Electronic Medical Records." Below this, the text "The following Policy Statement" is followed by a "Delete" link and the text "Permission to View and Print granted if Patient in system OPR and Patient assigned to Caregiver User."

Minimal Interference with Legitimate Use

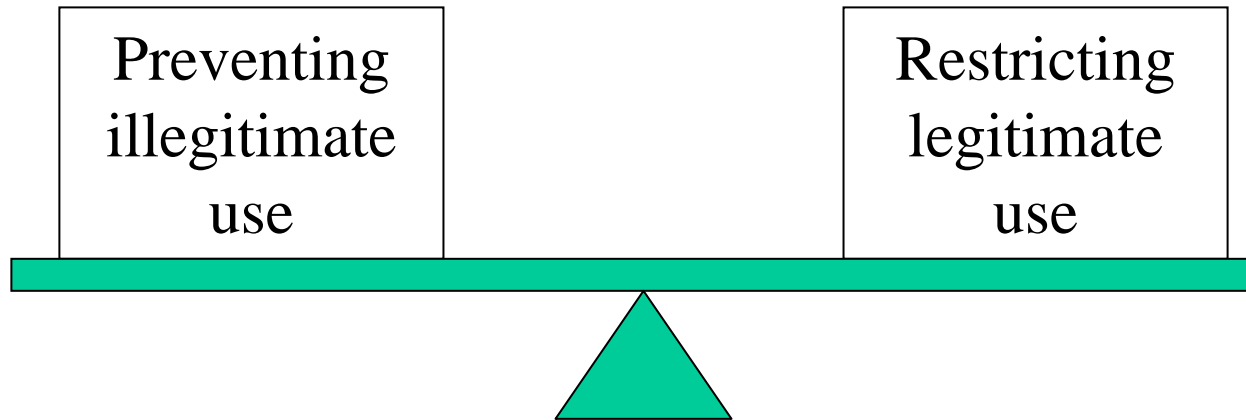

The right information to the
right person at the right time

Minimal Interference with Legitimate Use

- Apply policy before use with a Break-the-Glass override
 - “No current policy allows you to access this patient record, but we know policy may be deficient. If you must use the record say so and expect a followup query.”
- Apply policy after the fact
 - For a known, authenticated user, never deny access. Apply policy after the fact to determine followup.

Electronic Medical Record Audit Trail

For Dr. William Genner, Id 098765

Date 2001-11-10

Criteria Patient: Kevin M. Pate, Id 123456789; Records: File PateXray.pdf

EMR	Activity	By	When	Details
PateXray	set perm	098765 Genner	2001-11-08 13:07	132457; read, 2 day from set
PateXray	open	132457 Spencer	2001-11-08 15:33	close 2001-11-08 15:36
PateXray	open	132457 Spencer	2001-11-08 19:13	close 2001-11-08 19:26

Questions

Merv Matson, *Chairman and Founder*
RightsMarket, Inc.
MatsonM@RightsMarket.com
(403) 571-1836

EMR

X-Ray Rep
Cumulative

ER Visits
Medications

Scheduler

Save Report As File:



File Na

PateXr

Sen

✉ PateXray.pdf - Message (HTML)

Send Save Print Copy Paste Undo Redo Forward Back Bold

File Edit View Insert Format Tools Actions Help

To... Dr. Mary Spencer

Cc...

Bcc...

Subject: PateXray.pdf

Dear Mary.

Please give my your opinion regarding the case we discussed this morning.

I have granted you rights to view EMR
www.Genner.RightsVault.com/PateXray.pdf
for 2 days from now.

Regards, Bill

There is satisf
increased activ
other abnorma
facet joint. Mil

Findings are ot

REPORT DETAILS

t: PATE, KEVIN M

mild
ir
cent

.pdf

Built on 'Authorize and Track'

every time, everywhere

RightsPublish

Web-based, end to end service to publish valuable digital property; eBooks & eMusic

RightsEnforcer

Integratable subsystem and products to persistently secure confidential/private digital records; *eg. Medical docs & audio transcripts*

RightsCore

Digital Rights Management (**DRM**) platform to secure digital objects, authorize and meter/track/audit their use, supporting offline and online use

The Internet

Copy and distribute digital objects, worldwide, point-to-multipoint, nearly instantaneously, nearly free.

Secure Inside HIS Only

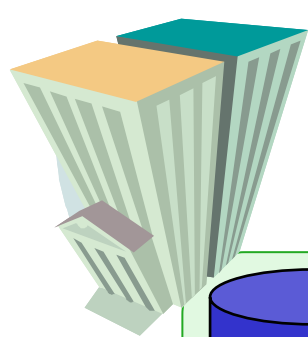

- GP's office
- Hospital
- Laboratory
- ...

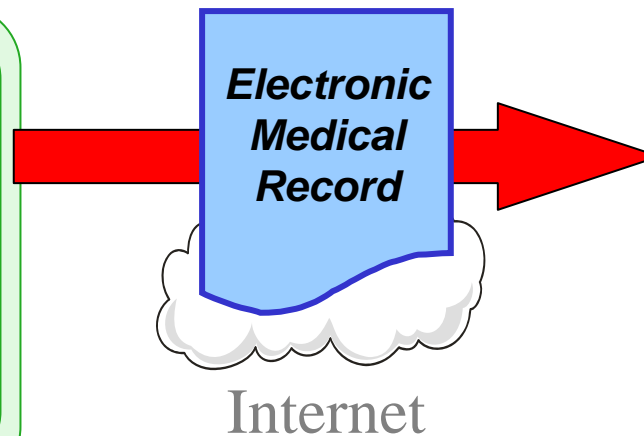
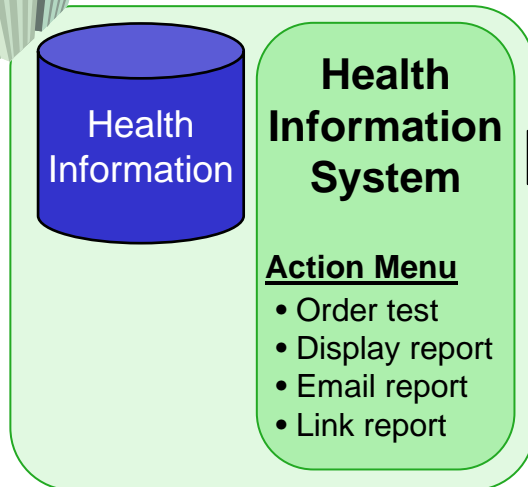

- Specialist
- Home Office
- Payer
- ...

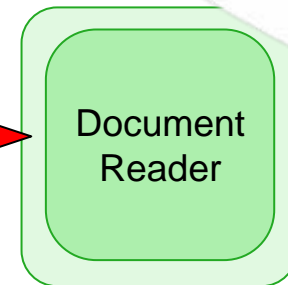

Legislation requires authorization and tracking of use, even after the EMR leaves the originating system.

Integrated Authorization and Tracking

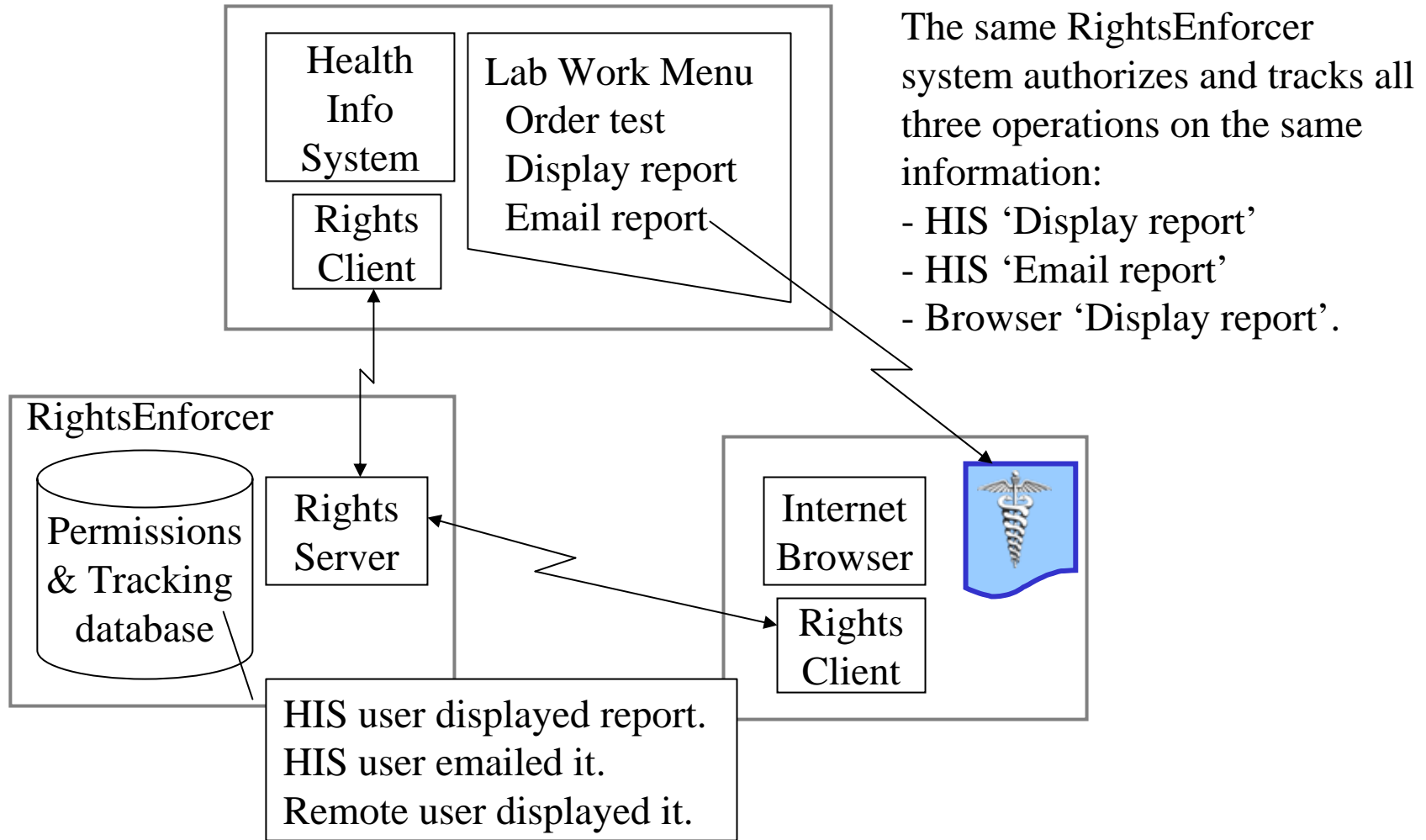

Security – Risk Model

		Security Strength		
	Attack, Risk	VPN	Persistent	
Location	Authentication	Strong ^{1,2}	Strong ^{1,2,3,4}	
	At Host System	NA ⁵	NA/Strong ⁶	
	In Net Transit	Strong	Strong	
	At Point of Use	Hack attack; carelessness; mischief	NA ⁵	Strong

1. Independent certification authority
2. Even stronger if two factor identification employed
3. Operator can act as own certification authority
4. Compatible with VPN
5. But compatible with Persistent
6. If employed at the host database system (probably selectively)

Persistent Security Advantages

- **Digital distribution with persistent security and tracking (not just delivery security and check-out tracking)**
- Comply with privacy law
- Unauthorized viewing / printing / copying eliminated
- Web-based installation
- Increased customer satisfaction: empower end user (including patient!) and build trust
- VPN compatibility

Configurations

Outsource RE/RS to RM/HISS

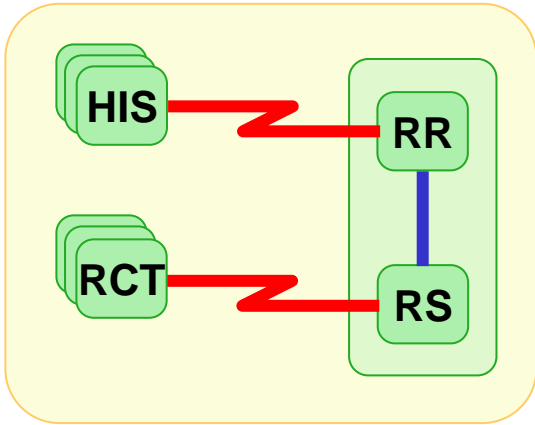

Outsource RS

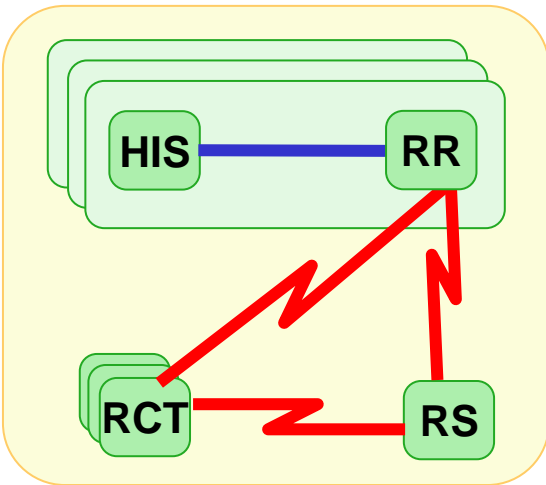

Large Government Department

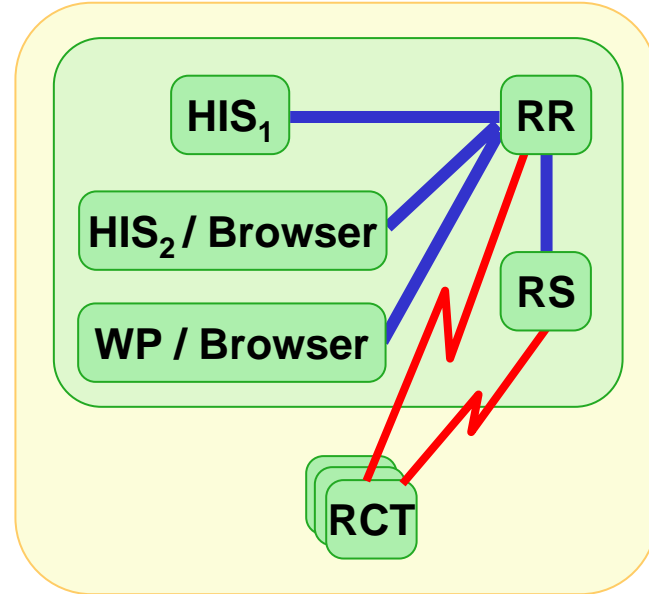

Large Hosp / RHA / HMO

